

Installation Guide 安装说明

WHIRLPOOL BATH 按摩浴缸

SHANGHAI KOHLER LTD., NO.368, MIN LE ROAD,
FENG XIAN DISTRICT, SHANGHAI, CHINA POST CODE 201419
上海科勒有限公司 上海市奉贤区民乐路368号 邮编: 201419

Before You Begin

- Please read these instructions carefully to familiarize yourself with the required tools, materials, and installation sequences. Follow the sections that pertain to your particular installation. This will help you avoid costly mistakes. In addition to proper installation, read all operating and safety instructions.
- All information is based on the latest product information available at the time of publication. Kohler Co. reserves the right to make changes in product characteristics, packaging, or availability at any time without notice.
- These instructions contain important care, cleaning, and warranty information-**please leave these instructions for the consumer.**
- This product complies with QB 2585-2007.

Product Notices

A. Installation Hazard Notification

DANGER: Risk of fire, electric shock, or injury to Persons. Read important safety instructions included in these instructions.

 **WARNING: Risk of electrical shock.** A licensed electrician should make all electrical connections.

 **WARNING: Risk of electrical shock.** Connect only to a circuit protected by a residual current device (RCD).

 **WARNING: Risk of electrical shock.** Disconnect power before servicing.

 **WARNING: Risk of injury or property damage.** Please read all instructions thoroughly before beginning installation, including the following Product Requirements.

NOTICE: Follow all local plumbing and electrical codes.

ATTENTION: Difference of the type of the plumbing, which may differ the drain speed.

 **WARNING: Risk of damp.** Silicone sealant shall be applied to connections of the bath drain pipe and the bathroom drainage pipeline.

ATTENTION: Temperature deviation. Water temperature at different parts of the bath may not be the same, which may cause the temperature detected and shown on the panel slightly differ from the actual water temperature in the bath.

B. Factory-Assembled Features

Factory installed components include water motor with power supply cord, electronic drain, controller, piping, water level sensor, user keypad, water pillow (optional) and keypad cable. Other than power wiring and plumbing, no assembly is needed.

 **WARNING: Unauthorized modification may cause unsafe operation or affect performance of the bath with airjets.** Do not make other modifications to the system in the absence of kit instructions, as this could adversely affect the performance and safe operation of the bath. Kohler China shall not be liable under its warranty or otherwise for personal injury or damage caused by any such unauthorized modification.

Product Requirements

A. Summary Of Key Requirements

- Observe all local plumbing and electrical codes.
- Install the unit to a level subfloor.
- Provide properly-dimensioned framing.
- Baths with airjets are designed for a variety of installations, depending upon the model chosen.
- Ensure a seal on the connection of bath drain pipe and bathroom drainage pipe.
- It is recommended to use blinds-style access panel to ensure ventilation and avoid damp on back of the bath.

B. Plumbing Specifications

If using a rim-mounted bath faucet, flexible connections between the valves and spout may be required. Confirm adequate mounting, connection space of specified faucet for your installation.

C. Product Inspection

Carefully unpack and inspect the massage bath for damage. Leave all materials in the carton during constructions to prevent damage.

D. Electrical Requirements

The installation must have a residual current device (RCD). The RCD protects against Line-to-ground shock hazard. Use a 220-240 V, 10 A (minimum), 50 Hz dedicated service for the massage bath.

Installation Requirements

A. Tools Required

- Adjustable pipe wrench
- Rule
- Level
- Safety shoes
- Safety glasses
- Square
- Screwdriver
- Pliers
- Utility knife
- Pencil
- Measuring Tape

Plus:

- Conventional woodworking tools and materials or conventional bricklaying tools and materials
- Drop Cloth
- Construction adhesive (optional)
- Cement or mortar (optional)

B. Materials Required

- Plumbers putty
- Wall coverings (if necessary)
- Silicone sealant
- Gypsum cement (optional)
- Construction adhesive (optional)
- Protective covering for bathtub
- Nails
- Silicone Sealant

Site Requirements

A. Old Bath Removal (If Applicable)

Disconnect the drain at the trap. Remove the old wall material. Slip boards under the old bath feet to protect the floor, and slide the old bath out of the recess as illustrated.

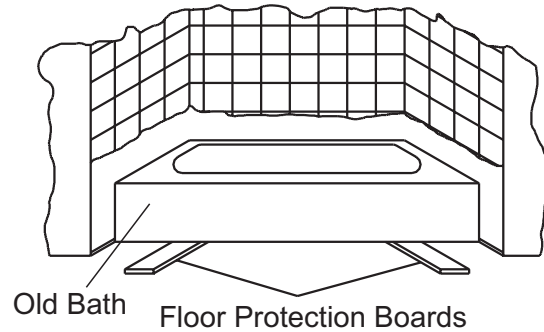

B. Prepare the Site

CAUTION: Risk of product damage. Do not support the bath by the rim.

NOTICE: Unless otherwise specified, floor support under the bath must provide for a minimum of 80 lbs./square foot (390 kg./square meter) loading.

- Make sure the flooring offers adequate support for your bath, and verify that the subfloor is flat and level.
- This bath may be installed in a drop-in or in an island installation. An island installation requires a four side surround. In both instances, make sure the deck is adequately supported.
- Install an access panel to allow the blower, the controller and the keypad to be serviced. Jalousie access is recommended. Please refer to rough-in for exact location of access panel.
- Construct brick or concrete supports.
- Provide a 2mm gap between the bath rim and the concrete or brick framing.

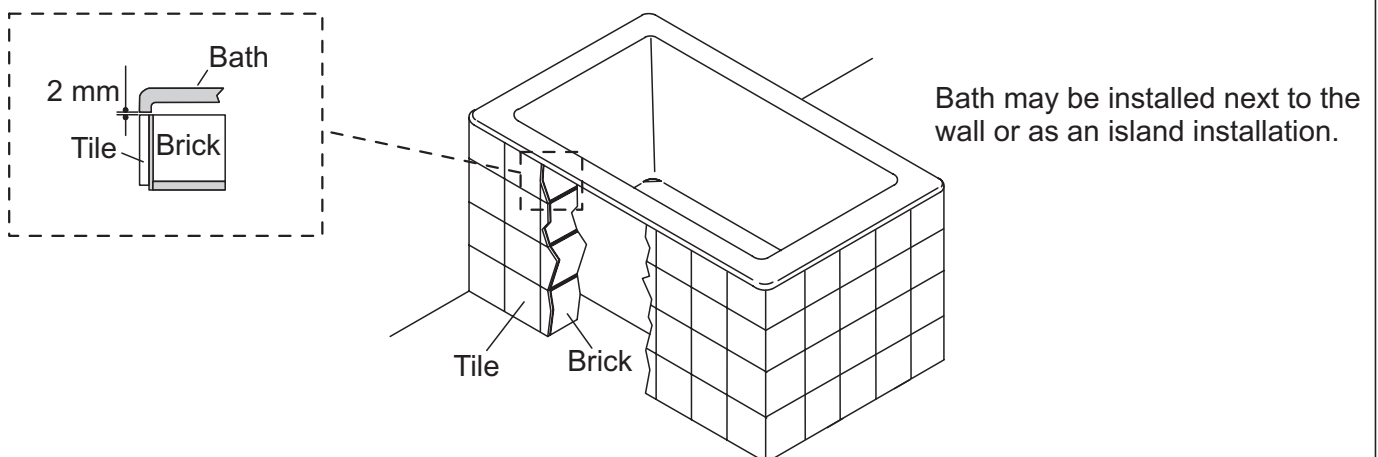

Before Installing the Bath

- A.** Your new bath has been manufactured to the highest possible standards, it has been factory tested and approved.
- B.** When removing bath from protective carton **DO NOT LIFT BATH BY PIPE WORK**. Inspect for any possible damage that may have occurred in transit. Position a clean drop cloth or similar material in the bottom of the bath to protect the finish. Be careful not to scratch the surface of the bath.
- C.** Identify blower and switch access location before proceeding with installation.
NOTE: NO BLOWER AND SWITCH ACCESS NO WARRANTY SERVICE. Ventilation must be provided to access panel. Jalousie access is recommended.
- D.** Refer to roughing-in to pre-arrange positions for hot and cold pipes, power supply and drainage hole before installation.
- E. IMPORTANT:** Bath must be installed level on all top edges.

Install the Bath

 **CAUTION: Risk of product damage.** Do not support the bath by the rim.

If the subfloor is not level, shim the bath support blocks as necessary.

A. Choose to Use Concrete or Mortar Bed

NOTE: Do not use gypsum concrete or drywall compound for this application, as they will not provide an acceptable, durable bond.

- Spread a 50mm thick layer of cement or mortar on the subfloor where the bath will be set. This will help secure, level, and support the unit.
- Brush a layer of waterproof paint on top of the cement or mortar bed.
- With help, carefully lift the bath into place.
- Insert the drain tailpiece into the bathroom drainage pipe. Make sure the bath is level and all feet are sufficiently supported.
- Remove the protective tape from the rim.

B. Install the Plumbing

 **CAUTION: Risk of property damage.** Ensure a watertight seal on the bath drain.

- Run water into the bath, and check the drain connections for leakage.
- Install the faucet valving according to the faucet manufacturer's instructions. Do not install the faucet trim until instructed. Open the hot and cold water supplies, and check the supply connections for leakage.
- Ensure a seal on the bath drain and the floor drain.

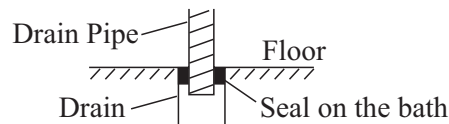

- Connect the cold water valve and pipe cleaning inlet valve with hose. Refer to roughing-in for position of the cold water valve.

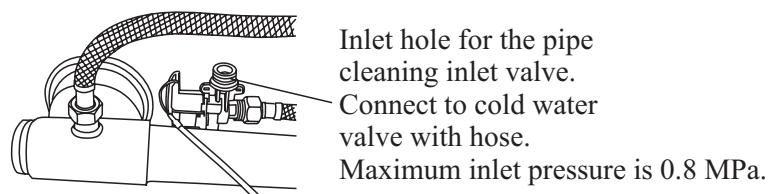

C. Make Electrical Connections

⚠ WARNING: Risk of electric shock. To reduce the risk of electrical shock, connect the control box to a properly grounded, grounding-type receptacle protected by residual current device (RCD's).

NOTE: Electronic parameter label located on the bath. This label also identifies the electrical rating.

- ❑ The position of equipotentiality is located near the water pump bracket and is used for connecting the building ground.
- ❑ Your bath is equipped with a cord and plug. The blower motor has been wired at the factory. A licensed electrician must install a dedicated RCD-protected, 220 V, 10 A, grounded water proof outlet.
- ❑ Plug the control box into this outlet.

D. Test Run the Bath

- ❑ Check all electrical connections.
- ❑ Make sure all piping connections are secure.
- ❑ Temporarily remove the plastic drop cloth or other protective sheeting from the bath.
- ❑ Push the electronic drain on/off button "🌀" to close the drain. Fill the bath to 300mm.
- ❑ Refer to "Bath Operation" to make sure that every function works well.
- ❑ Check the piping for leaks. Repair any leaks.
- ❑ Operate the bath. Check the air piping for leaks.
- ❑ Stop the massage and drain water.
- ❑ Return the plastic drop cloth or other protective sheeting to the bath. Check the drain connections for leakage.

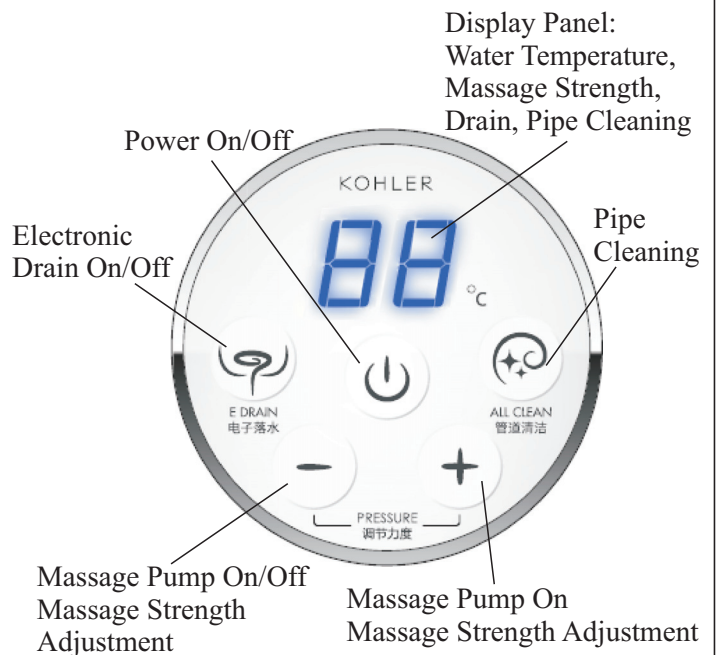

E. Seal the Bath Rim

⚠ CAUTION: Risk of product damage. Do not support the weight of the bath by the rim.

For sunken type installation, construct the ceramic or marble tiles. Seal the joints between the bath rim and the tiled wall with silicone sealant.

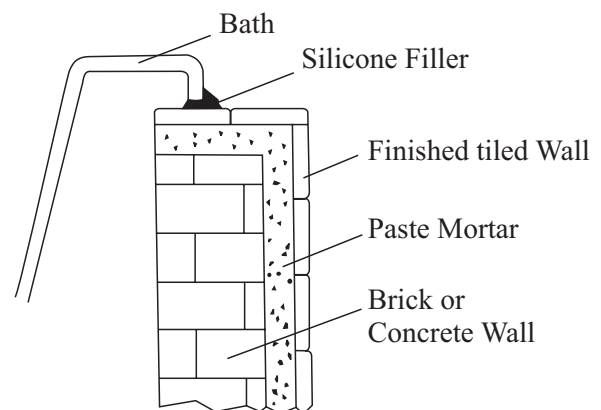

F. Apply Sealant to Bath with Apron

- ❑ After the bath is fixed, apply sealant around the connections of the bath and the wall.

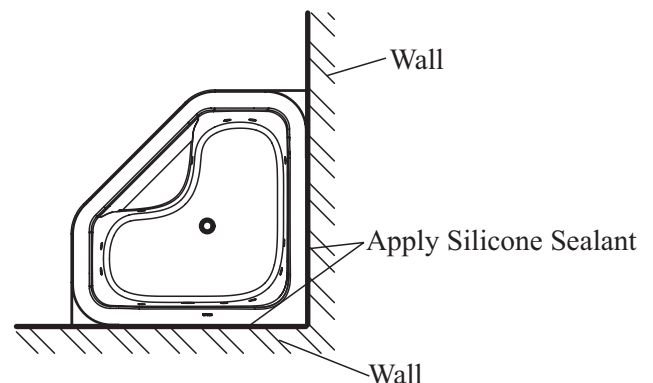

G. Install and Remove the Apron

If the apron needs removing, please follow the steps below:

- Remove the screw cap and loosen the screw.
- Pull bottom of the apron. Push the upper part of the apron inwards, pull down the apron and it can be removed easily.
- When installing the apron, insert the top of the apron into the enclosure, then the magnet at the bottom will function.

H. Drilling And Cutting Acrylic

DRILLING: Small holes can be drilled with a twist drill, but the cutting edge **MUST** be backed off with an oil stone (the sharp edge dulled). Large holes must be drilled with a hole saw. Maximum drill size-12mm. Drill speeds-6mm × 1800 RPM-12 mm × 900 RPM.

NOTE: Always drill from acrylic surface.

CUTTING: If for any reason the acrylic requires cutting, use a fine tooth hacksaw and proceed with caution. Edges can be smoothed with a second-cut file and medium-fine sandpaper. If the surface of the acrylic should happen to be damaged, it can be restored by polishing with an abrasive cleaner. Deep scratches can be removed by rubbing with 600 grade wet & dry sandpaper then polishing.

I. Clean-Up After Installation

- Use warm water and a liquid detergent to clean the surface of the bath. **Do not use abrasive cleansers**, as they may scratch and dull the surface. **Do not use powdered cleaners unless the cleaner is fully dissolved in water.** Solid substances could block the airjets. **Do not use bleach or ammonia cleaning solutions.** Chemically active cleaning solutions can damage the bath surface. Refer to the homeowners guide for normal cleaning recommendations.

Bath Function Check and Guide

A. Fill the Bath

NOTE: Please read these steps carefully before you operate your bath. Troubleshoot any problems using the "Troubleshooting" section.

NOTE: Please do not use the bath in case of outage. In this case, the electronic drain automatically opens and the bath can not be filled with water.

NOTE: Massage function may fail to start if waterlevel is lower than 300mm.

B. Keypad Instructions

□ Display Panel

Display water temperature in the bath and display air temperature when the bath is empty. Display massage strength when being adjusted.

Note: Before taking bath, please make sure of water temperature with hands.

When massage pump is on, massage strength is displayed.

□ Electronic Drain

Start the drain by pushing the button "Ⓢ" once, drain animation is displayed. Push again to stop it.

Tip: When pushing this button, a slight sound can be heard from the drain at the bottom of the bath.

□ Power On/Off

Push the button "Ⓜ" to start system and enter standby mode.

Push "Ⓜ" to stop system.

□ Massage Pump On/Off and Strength Adjustment

Press "Ⓜ" or "Ⓢ", pump is on with massage strength of L0. Press "Ⓢ" again, and massage strength is changed to L1. Continue to press "Ⓢ", and massage strength will be increased to L6. Press "Ⓜ" again, and massage strength is decreased to L0. Continue to press "Ⓜ" to stop.

□ Pipe Cleaning

Start piping cleaning by pressing "Ⓢ", and pipe cleaning animation is displayed. Press again to stop pipe cleaning. Meanwhile, electronic drain is open.

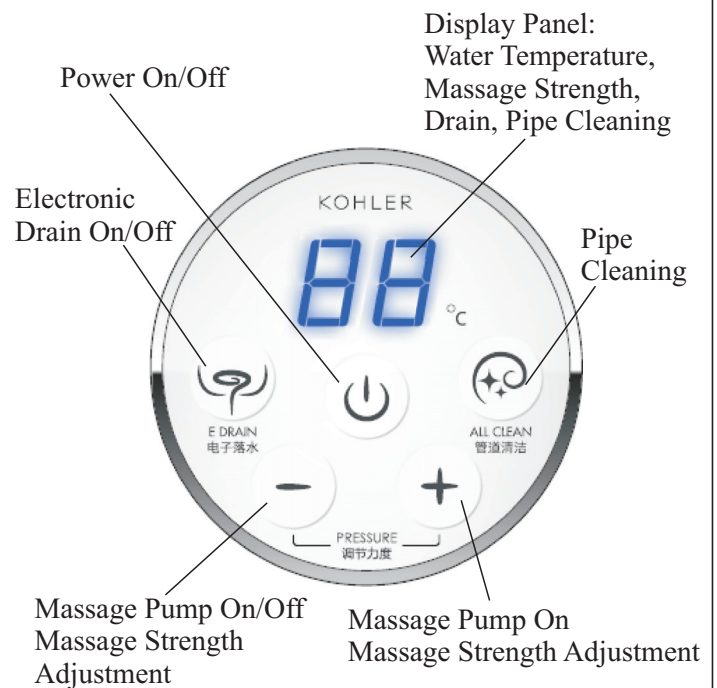

C. Operation Instructions

If the unit does not function properly, please refer to the "Troubleshooting" section.

□ Press power on/off "Ⓜ" to start system.

□ Press the electronic drain on/off button "Ⓢ" on the user keypad to close the drain.

□ Fill the bath. Massage pump can only be started when water level is above 300mm.

□ Observe water temperature displayed on the keypad for comfort and safety, make sure of water temperature with hand.

□ Carefully enter the bath basin.

□ Press pump on/off "Ⓢ" to start massage.

□ If desired, adjust massage strength by pressing "Ⓢ" and "Ⓜ".

OVERFLOW STATUS

- Water level reaches overflow level.
- The electronic drain automatically opens. Overflow animation is displayed and sound alarm starts.
- Turn off the tap. When water level is below overflow level, the electronic drain automatically closes. Sound alarm stops. Refer to roughing-in for overflow level..

⚠ NOTE: When the bath reaches overflow level, water level may rise quickly if you enter the bath, which may trigger the compelling drain function. Compelling drain function will discharge lots of water, so it is not recommended to enter the bath when it reaches overflow level.

STOPPING THE BATH

- Press "⊖" to stop massage.
- Carefully exit the bath.
- Press the electronic drain on/off button "⊕". Drain animation is displayed.

PIPE CLEANING OPERATION

- Press the purge button "⊕" and pipe cleaning animation is displayed.
- The bath automatically drains.
- After the bath is drained, the electronic drain is off and the bath will be filled automatically.
- The bath fills until water reaches the water level for automatic cleaning.
- The pump automatically runs for two minutes.
- Electronic drain opens. The bath automatically drains and pipe cleaning is finished.

POWER OFF STATUS

- The electronic drain automatically starts under power off status.
- Plug again, and the electronic drain is at draining status.

NOTE: Please do not use the bath in case of outage. In this case, the electronic drain automatically opens and the bath can not be filled with water.

COMPELLING DRAIN FUNCTION

- If the overflow level sensor does not work, you can use the compelling drain function to prevent water overflow to your bathroom. Refer to roughing-in for automatic drain water level.

Troubleshooting Chart

SYMPTOMS	PROBABLE CAUSES	RECORRECTIVE ACTION
1. Massage does not start.	A. Controller is not power on.	A. Set/reset RCD breaker; check wiring.
	B. User keypad cable loose or damaged.	B. Check wire connections. If necessary, replace user keypad.
	C. User keypad does not work.	C. Replace user keypad.
	D. Pump does not work.	D. Replace pump.
2. Pump stops automatically within 20 minutes.	A. RCD trips.	A. Correct RCD trips.
3. Pump does not stop automatically after 20 minutes.	A. Controller trips.	A. Replace controller.

4. Pump cannot start or stops when massage pump on/off button on user keypad is pressed.	A. User keypad cable loose or damaged.	A. Check wire connections. If necessary, replace user keypad.
	B. User keypad does not work.	B. Replace user keypad.
5. Pump operates but can not adjust massage strength.	A. User keypad cable loose or damaged.	A. Check wire connections. If necessary, replace user keypad.
	B. User keypad does not work.	B. Replace user keypad.
	C. Controller dose not work.	C. Replace the controller.
	D. Electronic adjustment valve does not work.	D. Replace electronic adjustment valve.
6. Pipe cleaning does not work.	A. User keypad cable loose or damaged.	A. Check wire connections. If necessary, replace user keypad.
	B. User keypad does not work.	B. Replace user keypad.
	C. Pump does not work.	C. Replace pump.
	D. Controller dose not work.	D. Replace the controller.
7. Cannot operate or stop electronic drain.	A. User keypad trips.	A. Replace user keypad.
	B. Controller trips.	B. Replace controller.
	C. Electronic drain mechanism does not work.	C. Replace electronic drain mechanism.
8. The bath cannot overflow.	A. Water level sensor trips.	A. Replace water level sensor.
	B. Electronic drain mechanism does not work.	B. Replace electronic drain mechanism.
9. Water level cannot be maintained after the bath is filled with water.	A. Water level protector functions.	A. Lower the water level in the bath.
	B. Water level surpasses overflow level.	B. Lower the water level in the bath.
	C. Overflow level is not correct.	C. Contact customer service personnel of Kohler to readjust the water level.
10. Water temperature cannot be shown.	A. User keypad cable trips.	A. Check wire connections, or replace user keypad.
	B. User keypad trips.	B. Replace user keypad.
11. Abnormity shown of water emperature.	A. Temperature sensor of electronic drain mechanism does not work.	A. Replace electronic drain mechanism.
12. Water runs discontinuously from the	A. Too much wastes in the bath.	A. when the bath is running, scratch in the pillow gap with a plastic ruler.

Important Consumer Information

Consumer Responsibilities

Please confirm that the massage bath is installed according to the installation instructions.

Massage system should be used at least once a month to avoid the possibility that the electrical fittings be damaged because of excessive moisture.

Cleaning Acrylic Surfaces: Do not use abrasive cleansers on any acrylic surfaces, as they will scratch and dull the surface. Wipe out the bath after each use to prevent a build-up of soap and scum.

If the acrylic surface becomes dull, an automotive type rubbing compound *may be used on the unit, followed by an application of paste wax.

*We recommend:

Rubbing compound mequiars mirror glaze 28 metal polish (import product) or "green oil".

安装之前

- 请仔细阅读此说明书以熟悉所需要的工具、材料及安装顺序。遵循适合您的特定安装要求的各项内容，避免昂贵的损失。除了要正确安装外，还应阅读操作及安全说明。
- 所有的资料是按最新出版的产品资料编写而成。科勒中国有限公司保留任何时候无须通知即可改变产品特性、包装或产品可供类型的权利。
- 说明书包括重要的安装、清洁及保养方面的内容，请把这些资料交给用户阅读。
- 本产品符合QB 2585-2007。

产品注意事项

A. 安装危险警告

危险：有起火、触电或人员受伤的危险。 请阅读本说明书内的重要安全指示。

 **警告：有触电的危险。** 请找合格的电工来进行所有的线路连接。

 **警告：有触电的危险。** 仅能和由漏电保护器(RCD)保护的电路相接。

 **警告：有触电的危险。** 工作之前先切断电源。

 **警告：有受伤或财物受损的危险。** 开始安装之前，请先彻底阅读所有说明，包括以下的产品要求。

注意：请遵守所有的本地卫生管道和电气规范。

注意：由于用户的下水管道型式不同，可能使产品的排水速度不同。

 **警告：产品严重受潮风险。** 浴缸排水管与浴室排水管道连接处应做密封处理。

注意：温度显示偏差。 由于浴缸内的水温不均匀，导致检测并显示到面板的温度可能同浴缸内的实际水温存在小的偏差。

B. 由厂家组装的部件

工厂已经对部件进行了安装，包括带电源线的水泵、电子排水、控制盒、管道、水位传感器、控制面板、信号线、出水浴枕(选配)等。除了电源线和管道连接，不再需要任何安装。

 **警告：未经授权的更改会导致浴缸不安全运转或者影响浴缸的性能。** 在没有专业人员的指导下，请不要对系统进行任何更改，因为这样可能导致浴缸不安全运转或者影响浴缸的性能。由于此种未经授权的更改所导致的人员伤害或损失，科勒公司将不承担任何保修责任或赔偿责任。

产品要求

A. 关键要求的总结

- 请遵守当地的卫生管道和电气规范。
- 在水平地面上安装浴缸。
- 提供适当尺寸的结构。
- 浴缸的设计适用于不同的安装方式，请按型号来选定。
- 浴缸排水管与浴室排水管连接处应作密封处理。
- 为了利于浴缸背部通风，减少受潮风险，建议使用百叶窗式检修门。

B. 卫生管道规格

如果是在浴缸边缘安装水龙头，必须以软管连接阀体和水龙头，确认安装是否适当，及指定的水龙头连接空间是否足够。

C. 产品检查

小心打开包装箱并检查浴缸是否损坏，施工期间将所有的材料都留在箱内，以防止损坏。

D. 电气要求

安装时必须有漏电保护器(RCD)。RCD可避免线路接地故障而触电的伤害。请使用一条220-240伏特，10安培(最小)，50赫兹的专用电路供浴缸使用。

安装要求

A. 所需工具

- 管道扳手
- 刻度尺
- 水平仪
- 安全鞋
- 安全眼镜
- 直角尺
- 螺丝刀
- 钳子
- 多用工具刀
- 铅笔
- 卷尺

B. 所需材料

- 管道用油灰
- 墙面保护罩(如需要)
- 密封硅胶
- 石灰水泥(选用)
- 建筑粘胶(选用)
- 浴缸保护套
- 钉子
- 密封硅胶

附加:

- 常规木工和砖瓦工的工具和材料
- 垫布
- 建筑粘胶(选用)
- 水泥或灰泥(选用)

场所要求

A. 拆除旧浴缸(如需)

在存水弯处拆下排水管。清除所有旧墙材料。在旧浴缸下面塞入护板以保护地面，并如图所示把旧浴缸从安装空间拉出。

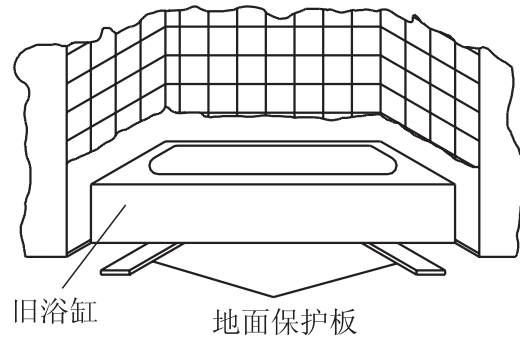

B. 场所准备

⚠ 警告：存在产品受损危险。请不要仅靠浴缸边缘支撑浴缸。

注意：除非特别注明，浴缸下面的底层地面必须提供至少80磅/平方英尺(390公斤/平方米)的荷载承重。

- 确保地面具有足够的支撑力支撑您的浴缸，并核实底层地面是水平的。
- 此浴缸可进行嵌入式安装或者岛屿式安装。岛屿式安装需要四面均有围墙。两种安装方式下，均要确定浴缸周边有足够的支撑。
- 为维修水泵控制器、操作面板提供维修入口，建议使用百叶窗式检修门。维修入口位置参见尺寸图。
- 建造砖头或者混凝土框架。
- 在浴缸边缘和柱型框架之间保留一个2毫米的缝隙。根据您的浴缸随附的初步安装信息在地面上确定安装位置。

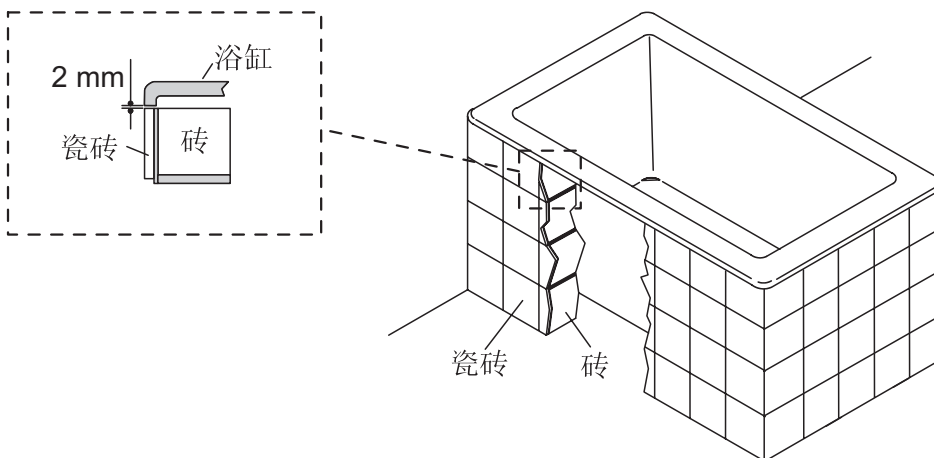

浴缸可以靠墙安装或岛屿式安装。

安装浴缸之前

- A. 本浴缸质量上乘，已经工厂检测通过。
- B. 从起保护作用的纸箱中取出时，**请不要拎着管道部分将浴缸取出**。检查可能有搬运造成的损伤。放置时在浴缸上罩一块干净的布或类似材料，以保护浴缸表面的光洁度。注意：不要在浴缸表面造成划痕。
- C. 安装前，请确定水泵和开关检修门的位置。
注意：无水泵和开关维修口，不能获得保修。检修门应通风良好。建议使用百叶窗式检修门。
- D. 请参考尺寸图上面的尺寸，在浴缸安装之前预排好冷热水管，电源和排水口。
- E. 注意：浴缸必须水平地放置。

安装浴缸

 **警告：存在产品受损危险。** 请不要仅靠浴缸边缘支撑浴缸。

如果底层地面不够水平，根据需要，调整浴缸支撑脚的高度。

A. 选择使用混凝土或砂浆层

注意：在此操作中，请不要使用石膏混凝土或者清水墙混合物，因为他们不能提供足够的持久的粘合力。

- 在浴缸将要置入的位置的底层地板上铺上50毫米厚的一层混凝土或者砂浆层材料。这将有助于支撑浴缸，让浴缸更安全、更水平。
- 在混凝土或砂浆层上刷一层防水涂料。
- 将浴缸小心地放置到位。
- 将排水管插入浴室排水管。确保浴缸处于水平位置，所有的支撑脚得到支撑。
- 将浴缸边缘的保护胶带移走。

B. 管道安装

 **警告：存在产品受损危险。** 请确保浴缸落水装置的水密性。

- 将水注入浴缸，检查排水连接是否漏水。
- 根据龙头生厂商的说明，安装水龙头阀门。在没有相关指示前，请不要安装龙头装饰物。打开冷热水进水口，检查供水连接是否漏水。
- 排水管与地漏连接处密封处理。

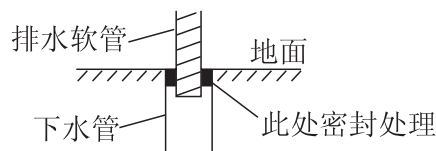

- 使用软管连接管道清洁进水阀与冷水阀门。冷水阀门位置请参考尺寸图。

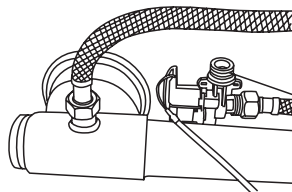

此为管道清洁进水阀入水口。
请用软管与冷水阀门相连。
最大进水压力为0.8MPa。

C. 电路连接

⚠ 警告：存在触电危险。为降低触电危险，请将控制盒和正确接地的受漏电保护器(RCD)保护的接地型插座相连接。

注意：浴缸有电器参数标签，此标签上同时注明了使用的额定电压和电流。

- 等电位位置位于水泵支架附近，用于连接建筑地。
- 您的科勒浴缸附带有电线和插头。所有电路连接已经在工厂完成。请由一名持证电工安装一个专用的220伏特、10安培的具有RCD保护的接地防水插座。
- 将控制盒插头插入此插座。

D. 测试浴缸的运转

- 检查所有的电路连接，连接良好。
- 确保所有管道连接安全。
- 暂时从浴缸上拿走塑料布或其他保护性材料。
- 按动按钮“”，关闭排水。注水入浴缸，水位达到300毫米。
- 请参照“浴缸操作”部分，确认各项功能正常。
- 检查管道是否漏水。如果有任何漏水现象，及时修理。
- 启动浴缸，检查管道是否漏水。
- 关闭按摩功能，进行排水。
- 将塑料布或其他保护性材料放回原位。

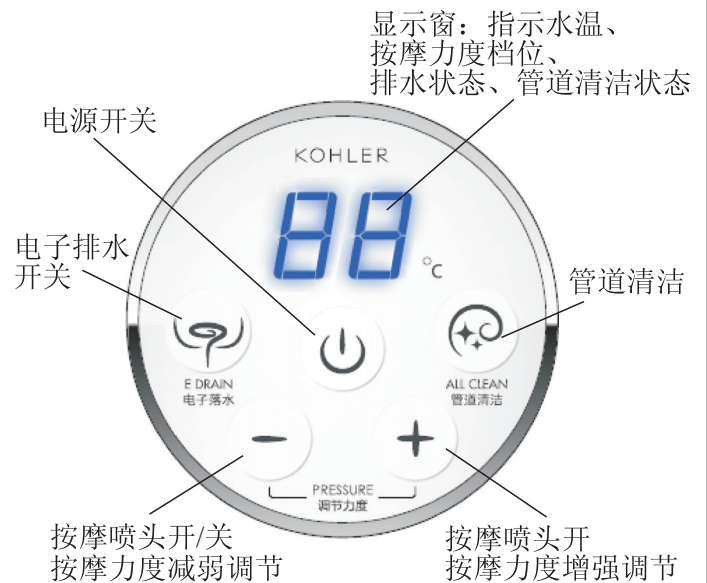

E. 浴缸边缘密封

⚠ 注意！！当心损坏浴缸！不要靠浴缸边缘支撑浴缸的重量。

对嵌入式安装，在敷上瓷砖或大理石贴面后，再用硅胶密封浴缸边缘和贴面的连接处。

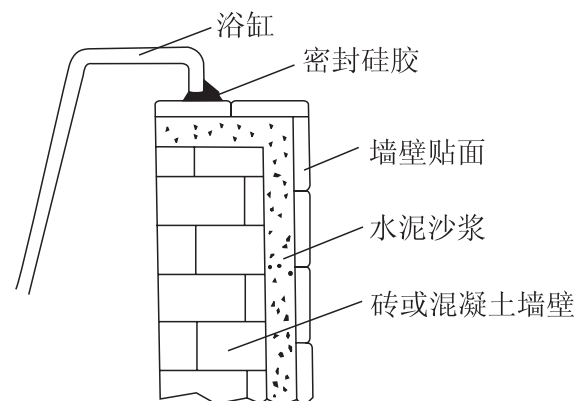

F. 带裙板浴缸的硅胶固定

- 浴缸就位后，浴缸靠墙边缘施以硅胶密封。

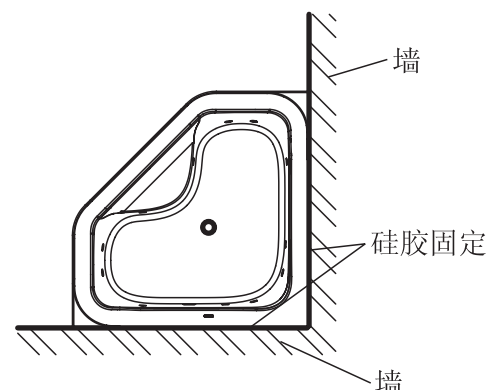

G. 安装拆卸裙板

如果需要拆卸裙板，请遵循如下步骤：

- 拿掉螺丝盖帽，拧下螺丝。
- 拉裙板底部，裙板上部稍稍往里推一点，把裙板往下移，裙板便拆下来了。
- 安装裙板时，先把裙板上部插入浴缸围边，然后底部磁铁吸住即可。

H. 在亚克力表面上钻孔和切割

钻孔：可用一麻花钻头钻小孔，但切削刃必须用一块油石磨钝。大孔须用孔钻加工。麻花钻头的最大尺寸为12mm，速度为6mm × 1800转/分至12mm × 900转/分。

注意：钻孔要从亚克力表面钻向浴缸背面。

切割：如果因故需要切割亚克力，请用优质齿型钢锯仔细切割。边缘可用一旧锉刀及中等砂纸磨平。如果亚克力表面受损，可用磨蚀性清洁剂抛光，将其恢复。深度刮伤可用600号水砂纸磨平，然后抛光。

I. 安装之后的清理工作

- 使用温水和液体清洁剂清洗浴缸表面。请不要使用磨损性的清洗剂，因为他们会擦伤浴缸表面，或者损伤浴缸表面的光洁度。请不要使用粉状清洁剂，除非这种清洁剂能够完全融于水。固体物质会堵塞气口。也不要使用漂白剂或者含氨类清洁剂。含化学物质的清洁剂将有损于浴缸表面。如果需要正常的清洁剂和清洁方法，请参照家庭用户指南。

浴缸功能检查和指南

A. 注水入浴缸

注意：在操作你的浴缸之前，请仔细阅读这些步骤。如果有任何故障，请参照“故障排除”部分。

注意：如遇断电状况，请不要使用浴缸。断电状态下，电子排水自动处于打开状态，浴缸无法蓄水。

注意：水位低于300毫米按摩功能无法启动。



B. 键盘使用说明

□ 显示窗



显示浴缸内水温。无水时显示空气温度，调节按摩力度时显示按摩档位。

注意：使用浴缸前请用手再度确认水温是否舒适。
当按摩喷头打开时则显示按摩力度档位。







□ 电子排水开/关键

按动按钮“”一次，浴缸排水打开，显示窗显示排水动画，再次按动按钮“”，浴缸排水关闭。提示：按动电子排水按钮同时可听到浴缸底部排水位置发出轻微的开/合声。

□ 电源开关键

按动按钮“”，系统上电，进入待机模式。
按动按钮“”，系统断电。

□ 按摩喷头开关和力度调节

按动按钮“”或按钮“”，喷头开，按摩力度为L0档，再按动按钮“”，按摩强度增加为L1档，继续按动按钮“”，依次递加至L6。再按动按钮“”，按摩力度递减至L0，继续按动“”关闭。



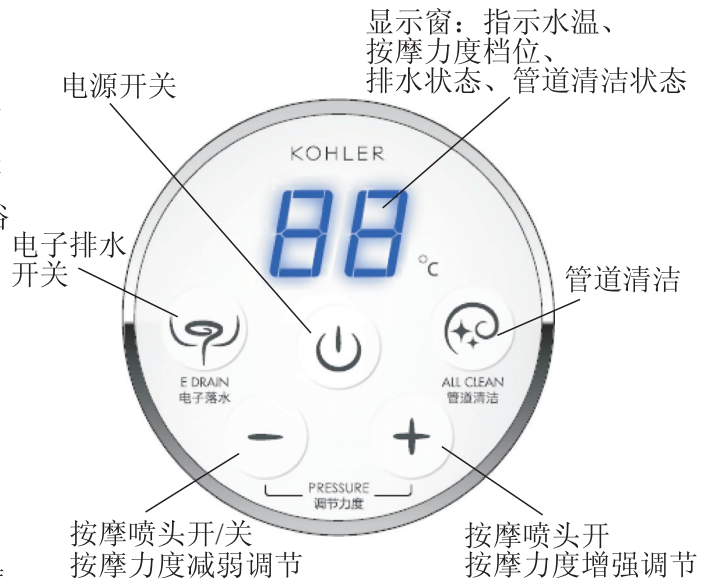

□ 管道清洁

按动按钮“”，开启管道清洁功能，显示窗显示管道清洁动画；再次按此键，关闭管道清洁功能，电子排水会打开。



C. 操作说明

如果你的浴缸运转不正常，请参照“故障排除”章节。

- 按电源开关键“”，系统上电。
- 按动电子排水开/关“”按键，关闭排水。
- 注水入浴缸，水位需达到300mm以上，按摩浴缸喷头才可打开。
- 观察键盘上显示的水温是否舒适安全，并实际用手确认。
- 小心地进入浴缸。
- 按下用户键盘上的按摩开/关按钮“”，开始按摩。
- 如果需要，按“”和“”调整按摩力度大小。

溢流状态

- 当水位达到溢流水位。
- 电子排水自动打开，显示溢流动画，并声音报警。
- 关闭注水龙头，水位下降到溢水水位以下时，排水自动关闭，报警解除。溢水水位值见尺寸图。

 **注意：**浴缸内水位到达溢水水位时，您进入浴缸导致水位上升较多时，可能会触发强制排水功能。强制排水功能排水量较多，建议不要在溢水水位进入浴缸。

停止浴缸运转

- 按“”关闭按摩功能。
- 小心地走出浴缸。
- 按动电子排水开/关按钮“”，打开排水，显示窗显示排水动画。

管道清洁操作

- 按下清洁按钮“”，显示窗显示管道清洁动画。
- 系统自动排干浴缸中的水。
- 水排干后电子排水关闭，自动进水。
- 注水至满足自动清洁的水位。
- 水泵自动运行两分钟。
- 电子排水打开，自动排干浴缸中的水，管道清洁结束。

断电时的状况

- 断电状况下电子排水自动打开。
- 重新上电，电子排水处于排水状态。

注意：断电状况下，请不要使用浴缸。断电状态下电子排水自动处于打开状态，浴缸无法蓄水。

强制排水功能

- 如果溢水水位传感器发生故障。电子排水具有强制排水功能。防止浴缸内的水流入您的浴室。强制排水水位见尺寸图。

故障处理表

现象	原因	处理措施
1. 按摩不能启动。	A.控制盒没有通电。	A.启动/重启RCD断路器；检查线路连接
	B.控制板线路松弛或受损。	B.检查线路连接，如有必要请更换控制面板。
	C.控制面板不能启动。	C.更换控制面板。
	D.水泵不工作。	D.更换水泵。
2. 未到20分钟水泵自动停止运转。	A.RCD故障。	A.排除RCD故障。
3. 20分钟后水泵没有自动停止运转。	A.控制盒故障。	A.更换控制盒。

4. 按控制面板上的按摩喷头开/关按钮后，水泵不启动或停止运转。	A.控制面板电线松弛或受损。	A.检查线路连接，如有必要请更换控制面板。
	B.控制面板不工作。	B.更换控制面板。
5. 水泵运转，但是无法调节按摩力度大小。	A.控制面板电线松弛或受损。	A.检查线路连接，如有必要请更换控制面板。
	B.控制面板不工作。	B.更换控制面板。
	C.控制盒故障。	C.更换控制盒。
	D.电子调节阀故障。	D.更换电子调节阀。
6. 不能进行管道清洁。	A.控制面板电线松弛或受损。	A.检查线路连接，如有必要请更换控制面板。
	B.控制面板不工作。	B.更换控制面板。
	C.水泵不工作。	C.更换水泵。
	D.控制盒故障。	D.更换控制盒。
7. 无法打开或关闭电子排水。	A.控制面板故障。	A.更换操作面板。
	B.控制器故障。	B.更换控制器。
	C.排水机构故障。	C.更换排水机构。
8. 浴缸无法自动溢水。	A.水位传感器故障。	A.更换水位传感器。
	B.排水机构故障。	B.更换排水机构。
9. 浴缸注水后水位无法保持。	A.水位强制保护开关动作。	A.降低浴缸内的水位。
	B.水位超过溢水水位。	B.降低浴缸内的水位。
	C.溢水水位设定偏差。	C.可联系Kohler公司专业客服人员，重新调整水位。
10. 无水温显示。	A.控制面板线路故障。	A.检查线路，或更换控制面板。
	B.控制面板故障。	B.更换控制面板。
11. 水温显示异常。	A.排水机构内水温传感器故障。	A.更换排水机构。
12.出水枕头水帘断续。	A.浴缸内污垢过多。	A.运行过程中用塑料尺在出水枕头间隙中划几下。

重要的用户资料

用户的责任

请确认浴缸按照本安装说明书的要求被安装。

按摩系统至少每个月使用一次，以避免电气零件因过度受潮而导致损坏的可能。

清洗亚克力表面：请勿在亚克力表面使用磨损性的清洁用具，以免擦伤浴缸表面，使其失去光泽。每次使用后，将浴缸擦干，以防止肥皂和污垢沉积。

若亚克力表面失去光泽，先用汽车抛光剂*，然后再用粗腊打亮。

*我们推荐使用以下2种抛光剂：

- ① Mequiers 镜面光亮28金属上光剂。(进口)
- ② 抛光膏(绿油)。