

Homeowners Guide

用户手册

C³ Toilet Seat with Bidet Functionality

C³ 清舒宝智能座便盖

K-4107KR

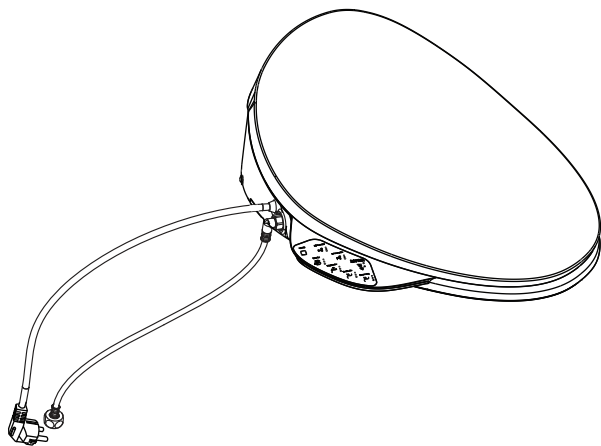

上海科勒电子科技有限公司

中国上海市宝山区丰翔路1955号 邮编: 200444

English page 2-21

中文页码 22-40

한글 페이지 41-60

繁體頁碼 61-79

1219876-KR01-C

KOHLER®

IMPORTANT SAFEGUARDS

SAVE THESE INSTRUCTIONS



WARNING: Risk of electric shock, fire, or personal injury.

This product must be grounded. Connect only to a dedicated 220~240V AC, 50/60Hz, 10A circuit protected by Ground-Fault Circuit-Interrupter (GFCI) or Earth-Leakage Circuit-Breaker (ELCB).



WARNING: Risk of electric shock or product damage. Do not immerse or flush the product with water.

IMPORTANT! Risk of product damage. Do not install this seat in a location where water might be splashed on the product.

IMPORTANT! Risk of product damage. Do not install this seat in a location exposed to excessive moisture where condensation might form on the product surface. Please ensure sufficient ventilation in your surroundings to prevent possible damage to electronic components.

IMPORTANT! Risk of product or property damage. Pushing or pulling on the water connection may cause water leakage.

IMPORTANT! Risk of product damage. Do not apply excessive force on the spray wands to avoid product damage.

IMPORTANT! Risk of product damage. In areas where water may freeze in the pipes, make arrangements to keep the pipes warm. Any water remaining in the seat may freeze during storage during the winter. Allow the unit to warm to room temperature before reinstalling or using.

IMPORTANT! Risk of product damage. Do not supply electrical power to the unit until the plumbing installation work has been completed; it could cause the product to malfunction.

NOTE: The thermal protectors may trip during storage or transportation in warm weather causing the unit to not operate. Allow the unit to cool to room temperature before installation or operation.

When using electrical products, especially when children are present, basic safety precautions should always be followed, including the Following:

DANGER - To reduce the risk of electrocution:

- Do not place or store this appliance where it can fall or be pulled into a bath or sink.
- Do not place in or drop into water or other liquid.

IMPORTANT SAFEGUARDS (cont.)

- Do not reach for a product that has fallen into water. Unplug immediately.

WARNING - To reduce the risk of low grade burns, electric shock, fire or injury to persons:

- Close supervision is necessary when this appliance is used by or near the very young, the elderly, or handicapped people. Children should not be permitted to use or touch this appliance. Do not leave children unattended in any room where this product is installed.
- For children and aged people who are unable to regulate temperature by themselves, help is required to regulate temperatures of the toilet, water and wind to the suitable grade.
- Use this appliance only for its intended purpose as described in the manual. Do not use attachments not recommended by Kohler Co.
- Do not lean on seat cover when using product.
- Never operate this appliance if it has a damaged cord or plug, if it is not working properly, if it has been dropped, damaged, or dropped into water.
- Install this product properly by following the installation procedure.
- Only authorized persons can install or repair the unit. Do not attempt to service this appliance yourself, doing so could void the warranty.
- Keep the cord away from heated surfaces.
- Never drop or insert any objects into any opening or hose.
- Do not use outdoors or where aerosol spray products are being used or where oxygen is administered.
- Always follow the grounding instructions in this manual before plugging in the unit.
- Do not splash water on power plug.
- Please avoid long time sitting on the heating-seat for the prevention of low temperature burns.
- If the power cord was damaged, replacement by the manufacturer, the Maintenance Department or a similar department professional is necessary, to avoid accidents.

Specifications

Water supply pressure		0.7kgf/cm ² (dynamic pressure)~7.5 kgf/cm ² (0.07MPa.(dynamic pressure)~ 0.74MPa.)		
Electrical power		220~240V AC 50/60Hz 1200W		
Power cord length		About 1.5m		
Outline dimension of product		521mm x 435mm x 157mm		
Product weight		About 3.0Kg		
Operation environment		1~40℃		
Cleaning	Wand spray flow	Rear wash	0.40~0.79L/min	
		Front wash	0.40~0.79L/min	
	Instantaneous heating power		1200W	
	Cleaning water temp		Five-speed adjustable (Room temperature to 39℃)	
	Spray time (the longest)		300s	
	Number of nozzle		1	
	Nozzle adjustment		5 Positions	
	Pulsate cleaning		On/Off	
	Oscillating cleaning		On/Off	
	Safety devices	Overheating prevention	Thermal fuse, heating element thermal cut-out	
Back-flow prevention		Check valve		
Comfort	Heated Seat	Heater maximum power	40W	
		Temperature adjustments	Five-speed adjustable (Room temperature to 39℃)	
		Safety devices	Thermal fuse, heating element thermal cut-out	
	Seat cover		Slow close	
	Seat		Slow close	
	Dryer	Maximum fan air flow	0.19m ³ /min	
		Maximum heater	200W	
		Temperature adjustment	Five-speed adjustable (Room temperature to 39℃)	
		Safety devices	Thermal fuse, heating element thermal cut-out	
	Deodorizer	Maximum fan air flow	0.19m ³ /min	

Specifications(cont.)

Sanitary	Self-cleaning nozzle	Provided
	Quick-release body	Lever activated by release button
	Antibacterial material	Seat, seat cover
	Nozzle UV germicidal	Once a day
Other	Keypad and Panel Diagram	Side in Seat
	Seating sensing	Hidden in Seat
	Night lighted bowl	2 blue LED s - Auto On/Off

Thank You For Choosing Kohler Company

Thank you for choosing a Kohler product. Kohler craftsmanship offers you a rare combination of proven performance and graceful sophistication that will satisfy you for years to come. The dependability and beauty of your Kohler product will surpass your highest expectations. We are very proud of our products here at Kohler and we know you will be too.

Please take a few minutes to study this Homeowners Guide. Pay special attention to the care and cleaning instructions.

All information in this manual is based upon the latest product information available at the time of publication. At Kohler, we constantly strive to improve the quality of our products. We reserve the right to make changes in product characteristics, packaging or availability at any time without notice.

Keypad and Panel Diagram

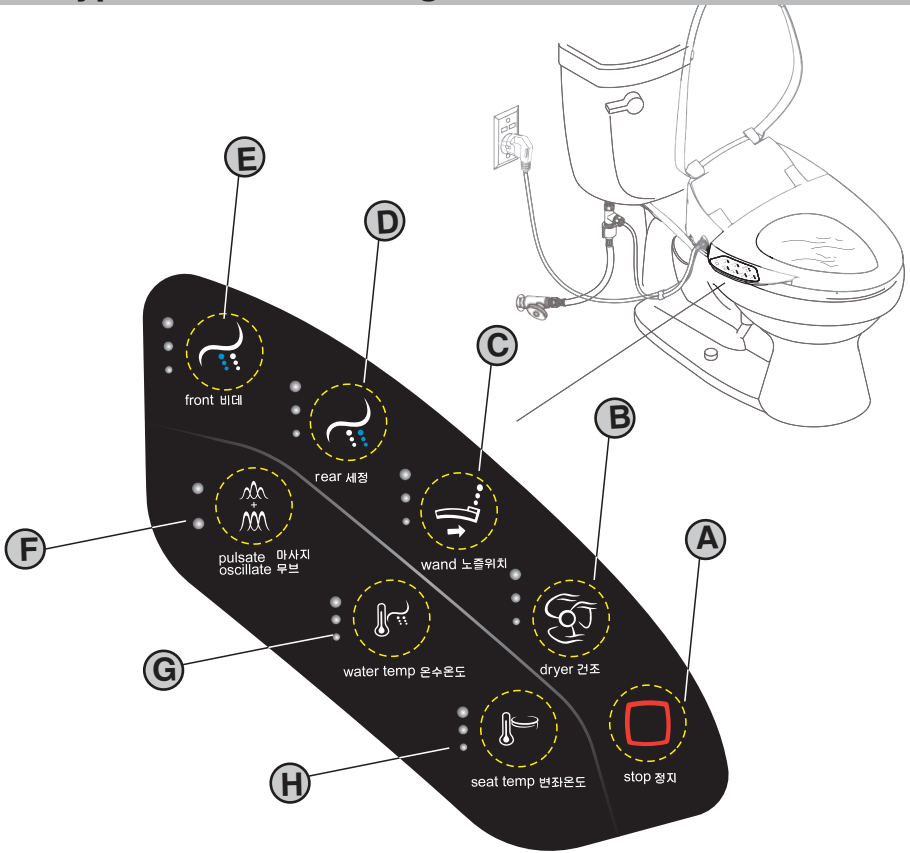

Operation

□ A - Stop

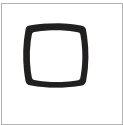

When flushing or heater is activated, the flushing or heater features can be halted by pressing the STOP button. When the user is seated, the deodorizer feature is activated automatically. Only when deodorizer feature is activated can it be deactivated by pressing the STOP button. After the deodorizer feature is deactivated, it will no longer be activated before being reseated.



Press and hold the STOP button for two seconds, the night light will be turned on or off. When it is turned off (with a long tone), the night light is deactivated; while it is turned on (with a short tone), the night light will be controlled automatically by the environment light (if the environment is dark, the light will be turned on, otherwise it will be turned off).

B - dryer



When being seated, the heater feature will be activated by pressing the HEATER button. If the wash feature is activated, it will be halted immediately.

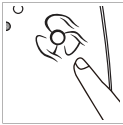

The indicator will display the current heater temperature, and the temperature of warm air can be changed first from low to high and then from high to low, stage by stage cyclically by pressing the HEATER button continuously. This feature will stop automatically after running continuously for 4 minute.

C - Bidet Wand Position



In the flush state, the bidet wand can be controlled by pressing the BIDET WAND button, and the distance of bidet wand can be changed first from short to long and then from long to short cyclically by continuously pressing the BIDET WAND button.

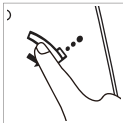

In the case when nobody is seated, press and hold the BIDET WAND button for over 2 seconds, the bidet wand will extend. Press and hold the BIDET WAND button for over 2 seconds again, the bidet wand will retract. If there is no action on the button for 2 minute, the bidet wand will retract automatically.

D - Rear



Press REAR WASH button to activate rear wash and the current flushing intensity will be shown.

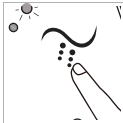

In the rear wash state, the flushing intensity can be changed first from low to high and then from high to low, stage by stage cyclically by continuously pressing the REAR WASH button. It will stop automatically after 5 minutes of continuous flushing.

E - Front



Press FRONT WASH button to activate front wash (female exclusive use) and the current flushing intensity will be shown. In the front wash state, the flushing intensity can be changed first from low to high and then from high to low stage by stage cyclically by continuously pressing the FRONT WASH button. It will stop automatically after 300 seconds of continuous flushing.

F - Pulsate+Oscillate

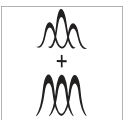

In the flush state, press this button to activate pulsating flush.

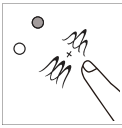

The feature will be changed cyclically from pulsate, oscillate, pulsate/oscillate, pulsate/oscillate off (return to front or rear flush), and the corresponding small lamp will be lit. If the pulsate/oscillate flush is turned off (return to front or rear flush) the indicator light will not light.

□ **G - Water temperature**



The temperature of flushing water can be changed first from low to high and then from high to low, stage by stage, and back to off again, cyclically by pressing the WATER TEMPERATURE button. The indicators will be lit up to show the parameter of corresponding water temperature. If it is turned off, the indicator will not light.

□ **H - Seat temperature**



The temperature of the ring can be changed first from low to high and then from high to low stage by stage, and back to off again, cyclically by pressing the RING TEMPERATURE button. The indicators will be lit up to show the parameter of corresponding ring temperature. If it is turned off, the indicator will not light.

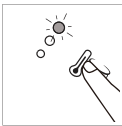

Press and hold the RING TEMPERATURE button for 2 seconds, the energy-saving feature will be turned on (with a short tone) or turn off (with a long tone). The ring temperature light flashing indicates that the energy-saving feature is turned on; while the ring temperature light stop flashing indicates that the energy-saving feature is turned off, or while being seated, the cistern and seat heaters will be turned off.

One week after the activation, the ring performs an automatic detection in user's habitual routine. Starting from the second week, the ring automatically gets itself into Power Save mode when it is less used, depending on the detected user routine of the first week.

During the third week, the ring bases its judgment on the data collected during the previous week to decide when it enters into Power Save mode. It works the same for the following weeks.

□ **I - Installation instructions**

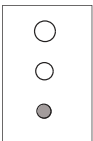

Low
small indicator lights up

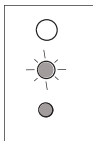

Low-mid
small indicator lights up and medium indicator flashes

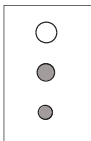

Mid
small and medium indicators light up simultaneously

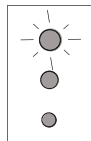

Mid-high
small and medium indicators light up; large indicator flashes



High
small, medium and large indicators light up simultaneously

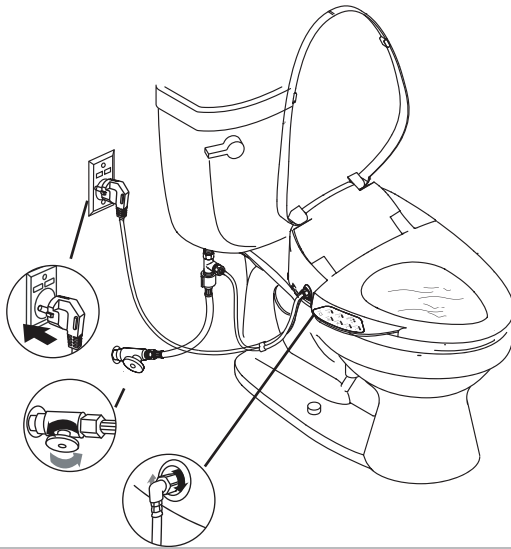

Preparation before the First Use

- Connect the inlet hose; open the water stop valve and connect the power.
- Toilet makes one short beep once it is plugged in. The nozzle stretches out and draws back once. Backlight on the side keyboard lights up and the night light flashes. All the actions last until the initialization process completes.
- Wait for the host to finish self-checking. During that time, it is normal to hear rotating sound of the motor and bicker. Self-checking is completed when the light flashes.
- When the unit is used for the first time, the following has been preset.

Front Wash:

- Water Temperature: mid
- Water Pressure: mid
- Position: mid

Seat temperature: mid

- Dryer temperature: mid
- Night light: on
- Power save: off

Rear Wash:

- Water Temperature: mid
- Water Pressure: mid
- Position: mid



Test the Functions

- Wrap the seat with plastic wrap to prevent water from spraying from the toilet during testing.
- The seat is designed not to function without an occupant. To activate the seat controls for testing purposes, when facing the toilet, place your hand or a damp wash cloth on the right side of the seat approximately 1/3 from the front of the seat (sensor area).
- Proceed to the “Keypad and Panel Diagram” and “Operation” Sections to test the various seat functions.

Care and Cleaning

For best results, keep the following in mind when caring for your Kohler product:

! **IMPORTANT!** Do not immerse product in water.

- **Test First** - Always test your cleaning solution on an inconspicuous area before applying it to the entire surface.
- **Do Not Let Cleaners Soak** - Do not allow cleaners to sit or soak on the product.
- **Avoid Abrasive Materials** - Use a soft, dampened sponge or cloth. Never use an abrasive material such as a brush or scouring pad to clean surfaces.

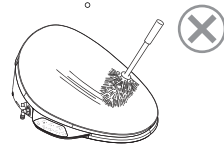
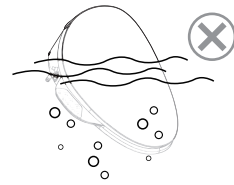

- **Wipe Clean** - Wipe surfaces clean with a damp cloth immediately after applying cleaners. Wipe away and dry any overspray that lands on nearby surfaces.

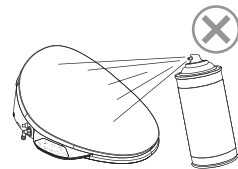

Cleaning Your Seat

- Avoid abrasive cleaners, detergents, disinfectants or cleaning products in aerosol cans.

Care Tip: Clean the seat with a mixture of dishwashing liquid and water, or any of the products listed for toilet seats, using a damp soft sponge or cloth. Dry with a soft towel and let the seat air dry.

- Do not allow abrasive chemicals and cosmetics (such as fingernail polish and aftershave) to come in contact with the toilet seat, as they can damage the finish.



! **NOTICE:** Failure to comply with these cleaning instructions may void Kohler's warranty obligations.

! **NOTE:** Success with cleaners and procedures is dependent upon such factors as the hardness and temperature of the water, using exact quantities of ingredients, changes in cleaning formulas, and the condition of the product being cleaned. Since there are variations within these factors, Kohler cannot guarantee the effectiveness of the formulas mentioned.

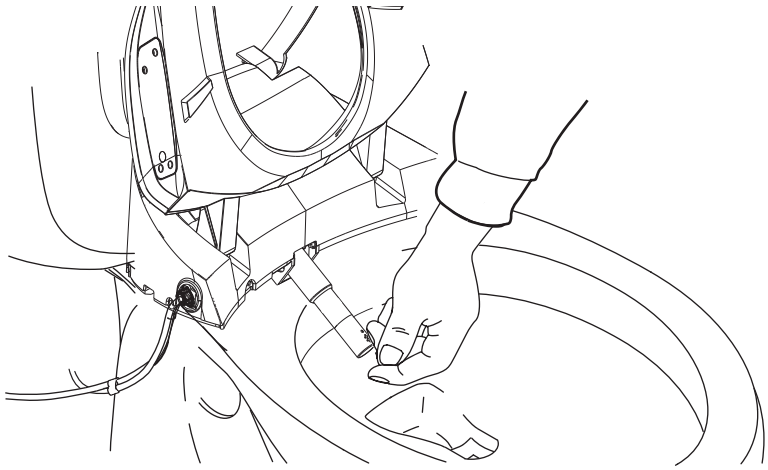

Clean the Nozzle

NOTE: The Nozzle can only be extended for cleaning when the seat is not activated or occupied.

- Open the lid and ring.
- Press and hold the BIDET WAND button for over 2 seconds, clean the bidet wand with a soft mane brush until the bidet wand fully extend.
- After having the bidet wand cleaned, press and hold the BIDET WAND button for over 2 seconds, the bidet wand will retract. Otherwise, the bidet wand will automatically retract after a while.

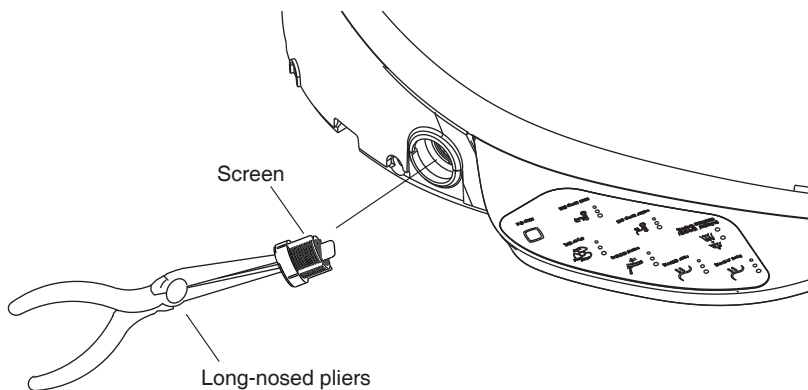

Clean the Screen

IMPORTANT! Risk of product damage. Use care not to crossthread the connection.

- Turn off the water supply at the supply stop.
- Remove seat inlet pipe.
- Using a long-nosed pliers carefully remove the screen from the seat inlet (see illustration).
- Clean the screen with a soft-bristled brush.
- Reinstall the screen.
- Take care to face right in position to the thread. Reconnect the water supply hose to the seat.
- Check all connections for leaks and make any adjustments as needed.
- Turn on the water supply.

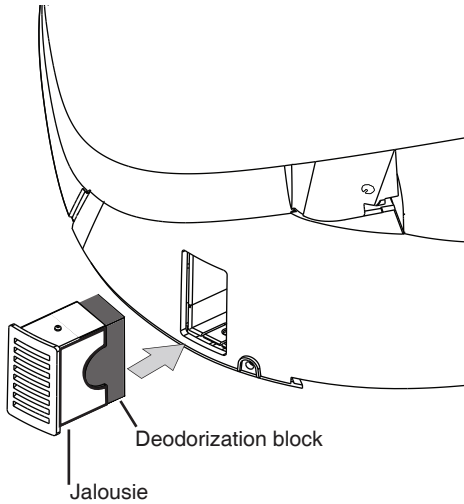

Changing Deodorization Block

IMPORTANT! Risk of product damage. Do not apply excessive force to the louver while disassembly. Otherwise, it may be damaged.

- Unload the jalousie.
- Pull out the original deodorization block.
- Replace with a new one.
- Load the jalousie.
- Make sure no impurities in the deodorization assembly before renewing the deodorization block.

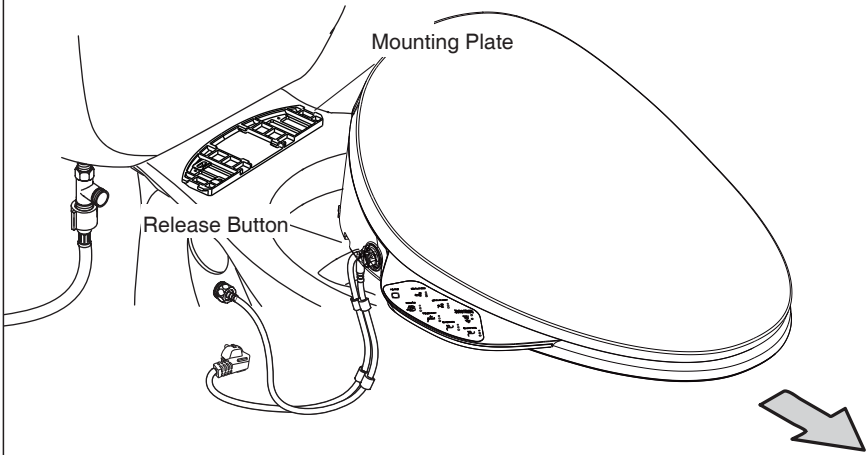

Remove the Seat

- Turn off the water supply at the supply stop.
- Turn on flush function to relieve any pressure from the water supply hose.
- Unplug the seat from the electrical outlet.
- Disconnect the water supply hose from the T-valve.
- Press the release button(see illustration).
- Slide the seat forward to disengage the seat front the mounting plate.

NOTE: The seat will contain water until drained. Refer to the “Drain the water from the seat” section.

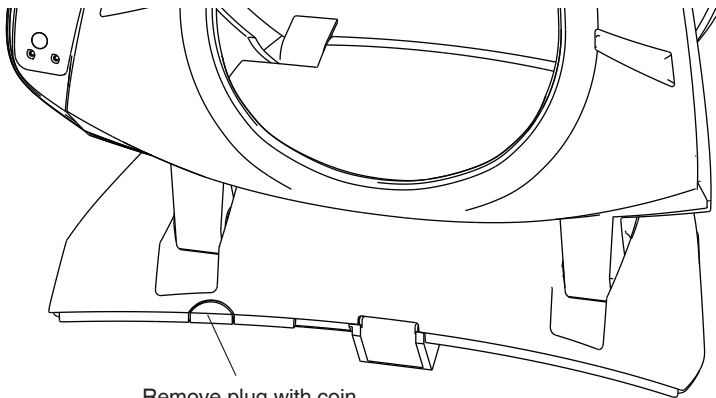

Remove plug with coin.

Drain the Water from the Seat



CAUTION! Risk of product damage. When the seat is not used for a long time or environmental temperature may have dropped to below freezing, the water should be drained from the seat.

- Turn off the water supply and unplug the unit.
- Remove the seat from the toilet. Refer to the “Remove the Seat” section.
- Drain the water from the seat.
- Reinstall the drain plug.

Troubleshooting

This troubleshooting guide is for general aid only. A Kohler Authorized Service Representative or qualified electrician should correct all electrical problems. For warranty service, contact your dealer or wholesale distributor.

Troubleshooting(cont.)

General Functions

Symptoms	Probable Causes	Recommended Action
1. Functions are not working	<p>A. Power failure occurred.</p> <p>B. The power cord is disconnected.</p> <p>C. Power cord suffers electricity leakage. Connector plug is not reset.</p> <p>D. You have not touched the seat sensing area.</p> <p>E. Thermal protector to open automatically to protect.</p> <p>F. None of the above actions correct the symptom.</p>	<p>A. Wait until the power is restored.</p> <p>B. Insert the power cord into an electrical outlet.</p> <p>C. Press the "Reset" icon on the plug.</p> <p>D. You have to sit inside the seat sensing area.</p> <p>E. Allow the seat to cool to room temperature.</p> <p>F. Contact a KOHLER Service Representative.</p>
2. Seat is loose	<p>A. Screws and nuts are loose.</p>	<p>A. Tighten the screws and nuts according to the installation guide</p>
3. No water comes out of the nozzle	<p>A. Seat does not detect user.</p> <p>B. Water supply stop closed.</p> <p>C. Water supply screen plugged.</p> <p>D. None of the above actions correct the symptom.</p>	<p>A. Sit on the seat.</p> <p>B. Power off and solve the problem, power on.</p> <p>C. Clean the screen according to the installation guide.</p> <p>D. Contact a KOHLER Service Representative.</p>

Cleansing Functions

Symptoms	Probable Causes	Recommended Action
4. No water flow	<p>A. The water supply stop is closed.</p> <p>B. The seat sensor is not detecting the user.</p>	<p>A. Open the water supply stop.</p> <p>B. See activating the seat information in the "Test the Functions" section.</p>
5. The water pressure is low	<p>A. The screen is clogged.</p> <p>B. Low supply pressure.</p>	<p>A. See the "Clean the Screen" section.</p> <p>B. Increase the pressure.</p>
6. Water stops flowing from the spray wand before I am finished cleaning	<p>A. One minute after pressing one of the spray icons, washing automatically stops.</p> <p>B. The seat sensor is not detecting the user.</p>	<p>A. Press the "Rear" or "Front" icon again.</p> <p>B. See activating the seat information in the "Test the Functions" section.</p>
7. Water keeps on dripping from nozzle side holes	<p>A. This is to prevent the unit inside part being over pressured.</p>	<p>A. None</p>

Troubleshooting(cont.)		
8. When seated, water flows out from the nozzle.	A. Residue water in the nozzle will be automatically discharged before use if it is not used for extended time.	A. None.
Slow Close Cover		
Symptoms	Probable Causes	Recommended Action
9. The speed of the seat and cover closure varies in summer and winter.	A. Due to change in room temperature.	A. None.
Seat Sensor		
Symptoms	Probable Causes	Recommended Action
10. Wash, Deodorizer, or Air functions operate when you press the icon while seat is not occupied.	A. The seat sensor is covered by an object or the seat is wet.	A. Remove any water or object from the seat sensor area.
11. Even though the seat is occupied, the spray function does not work.	A. The seat sensor may not be able to detect you depending on the way you are sitting.	A. Change your sitting position.
Air (Blower) Functions		
Symptoms	Probable Causes	Recommended Action
12. The hot blower stops during use.	A. Four minutes after pressing the "Air Speed" icon, blower automatically stops.	A. Press the "AIR TEMP" button again.
Deodorizer Functions		
Symptoms	Probable Causes	Recommended Action
13. The deodorizing blower feature doesn't work.	A. The seat sensor is not detecting the user. B. Press "STOP"	A. See activating the seat information in the "Test the Functions" section. B. See activating the seat information in the "Operation" section.
14. Odor is not removed.	A. Deodorization block is empty. B. Some people are more sensitive to odor.	A. Renew deodorization block. B. None.
Other		
Symptoms	Probable Causes	Recommended Action
15. The seat moves both up and down and right and left.	A. The bolts for the mounting plate that secure the main unit are loose.	A. Tighten the bolts of the mounting plate.

Service Parts

K-4107KR

1185019-SP
Installation Screw
Attachment



1102014-SP
Clip Attachment



1184968-SP
Cover Bumper



1183663-SP
Nozzle Gen Assy.



1085189-SP
Inlet Attachment

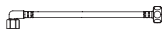

1194769-SP
CUSHION assy.

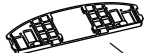

1185018-SP
Mounting Plate
Assy



1185006-SP
Water Tank Assy.



1184969-SP
Inlet Filter



1186587-SP
Cable of LED
night lamp

1185014-SP-
LID, COVER assy.



1184962-SP-
DE Back

1185012-SP
Deodorizer Assy.

1150820-SP
FILTER BLOCK



1185010-SP
air pump assy.

1085096-SP-
Fan Door

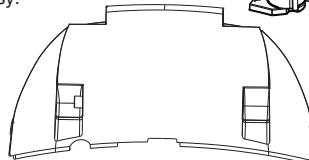

1185015-SP
Seat Damp Assy.



1185016-SP
Lid Damp Assy.

1186590-SP
Dry Centrifugal
Fan



1085187-SP
T-Valve



1185004-SP
Heater Assy.



1205946-SP
Control Module Assy.



1205727-SP
Power Line With
Gfci Plug



1185003-SP
Flowmeter Assy.

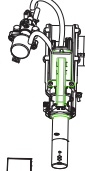

1194770-SP
Assign-nozzle Assy.



1186150-SP
Power Module
Assy.



1207946-SP
Membrane Side
keyboard



1186595-SP
PCBA Side
Keyboard



1182246-SP
Drive Module
Assy.(220V)



1185002-SP
Decompression-
Electromagnetic valve Assy.

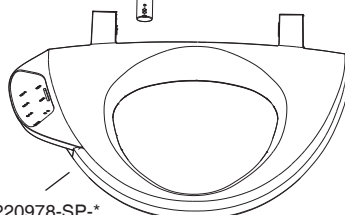

1220978-SP-
RING asm.



1185011-SP
Air Dryer Assy.

*Finish/color code must be specified when ordering.

THREE-YEAR LIMITED WARRANTY

Kohler warrants this plumbing product to be free of defects in material and workmanship during normal residential use for three years from date of purchase. **This warranty only applies to the plumbing product purchased and installed in countries/regions as listed below.**

If a defect is found in normal residential use, Kohler will, at its election, repair, replace or make appropriate adjustment where Kohler inspection discloses any such defects occurring in normal usage within three (3) years after date of purchase. Kohler is not responsible for labor charges, removal or installation, or other incidental or consequential costs other than those noted above.

If the product is used commercially, Kohler warrants that the product will be free from defects in materials and workmanship for one (1) year from the date of purchase, with all other terms of this warranty applying except duration.

IMPLIED WARRANTIES INCLUDING THAT OF MERCHANTABILITY AND FITNESS FOR A PARTICULAR PURPOSE ARE EXPRESSLY LIMITED IN DURATION TO THE DURATION OF THIS WARRANTY. KOHLER AND/OR SELLER DISCLAIMS ANY LIABILITY FOR SPECIAL, INCIDENTAL OR CONSEQUENTIAL DAMAGES.

Some countries/regions do not allow limitations on how long an implied warranty lasts, or the exclusion or limitation of special, incidental or consequential damages, so these limitations and exclusions may not apply to you. This warranty gives you specific legal rights. You may also have other rights which vary from country/region to country/region. This warranty is to the original consumer purchaser only, and excludes product damage due to accident, installation error, product abuse, or product misuse, whether performed by a contractor, service company, or the consumer. Improper care and cleaning will void the warranty.

To obtain warranty service, please contact your Dealer or Plumbing Contractor, or a Kohler Service Center using the information provided below. Please be sure to **provide all pertinent information regarding your claim, including a complete description of the problem, the product, model number, color, finish, the date the product was purchased and from whom the product was purchased. Proof of purchase (original sales invoice) must be provided to Kohler with all warranty claims.**

Kohler Warranty Obligor/Service Center for Region or Country of Purchase

Region/Country of Purchase

Address

China mainland

Kohler China Investment Co., Ltd.
Central Customer Service Centre
No.158, Jiang Chang San Road, Zhabei District,
Shanghai 200436, PRC
Toll-Free Service Call: 800-820-2628
400-820-2628

Thailand

Kohler (Thailand) Public Company Limited
16 FL. Jasmine City Bldg., 2 Sukhumvit 23,
Wattana, Bangkok, Thailand. 10110
Tel: +(66) 2204 6222
Fax: +(66) 2204 6224
E-mail: callcenterthailand@kohler.com

Hong Kong, Macau
and Taiwan

Kohler Asia Pacific Limited
29/F, Siu On Center, 188 Lockhart Road,
Wanchai, Hong Kong
Tel: +(852) 3125 7728
Fax: +(852) 2802 2162

Singapore, the
Philippines, Malaysia,
Indonesia, Vietnam,
South Korea, Brunei
and Japan,

Asia Customer Service Centre
No.158, Jiang Chang San Road, Zhabei District,
Shanghai, PRC Post Code: 200436
Tel: +(86) 21 2606 2572
Fax: +(86) 21 6107 8900

This is Kohler's exclusive written warranty.

重要的安全警示

保存这些说明



警告：触电，火灾或人身伤害的危险。本产品必须安全接地。只能连接到专用的220~240V AC，50/60Hz，10A，带接地故障断路器或接地漏电保护器的电路中。



警告：触电或产品损伤的危险。不要把产品浸在水中。

重要！产品损伤的危险。不要安装在水可能溅到的地方。

重要！产品损伤的危险。不要把产品安装在过分潮湿的地方，在这种地方，水汽可能凝聚在产品表面。请始终保持使用环境有足够的通风，以防止电子组件的损坏。

重要！产品损坏或财产损失的危险。硬推、硬拉水管接头可能造成水渗漏。

重要！产品损坏的危险。不要在喷嘴上施加过大的力，否则产品可能损坏。

重要！产品损坏的危险。在一些水可能在水管中结冰的地方，要做好水管保温的安排。任何留在产品里的水在冬天储存时都可能结冰。在重新安装或使用前请保证产品暖至室温。

重要！产品损坏的危险。在安装工作完成之前不要接通电源，这可能导致产品故障。

注意：温暖的气候时，热保护器在存储或运输过程中可能失灵，导致产品不工作。在重新安装或使用前请保证产品冷至室温。

当使用电器产品时，尤其当儿童在场时，应该遵守基本的安全防范，包括如下：

危险 - 降低触电的危险：

- 不要把此设备放置在可能掉落或可能被拉入浴缸及水槽的地方。
- 不要放置或掉到水及其他液体中。
- 不要触及掉进水中的产品。如果掉进水中，请立刻拔掉插头。

重要的安全警示（续）

警告 - 避免低温灼伤、触电、火灾或人身损伤

- 当儿童、老年人、残疾人使用或靠近此产品时，近距离的监护是必需的。儿童不应该被允许使用或接触此产品。不要让儿童独自呆在安装有此产品的房间。
- 对于无法自己进行温度调节操作的儿童和老人，需要帮助将座便盖的圈温、冲水温度及风温调节到合适的档位。
- 仅按照手册中所描述的方式使用本产品，不要使用科勒不推荐的附件。
- 使用时请勿倚靠在盖板上，以免损坏产品
- 如果有以下情况请不要使用本产品：电源线、插头及产品有损坏；产品不能正常工作；产品掉入水中。
- 根据安装说明正确地安装本产品。
- 只有专业人士可以修理此产品。不要试图自己维修此产品，否则保修无效。
- 使电源线远离加热表面。
- 不要把任何物品掉入或插入管路和开孔处。
- 不要在户外或者微粒喷雾设备正在被使用的地方使用本产品。也不要再在给养的地方使用本产品。
- 在通电之前必须按照说明书中的要求接地。
- 防止将水淋到电源插头上。
- 请避免长时间让裸露的皮肤接触加热座圈，以免低温灼伤。
- 如果电源线损坏，为了避免危险，必须由制造商、其维修部或类似部门的专业人员更换。

规格				
供水水压(动压)		0.7kgf/cm ² (动压)~7.5 kgf/cm ² (0.07MPa.(动压)~ 0.74MPa.)		
规格		220~240VAC 50/60Hz 1200W		
电源线长度		约1.5m		
产品外型尺寸		521mm x 435mm x 157mm		
产品重量		约3.0Kg		
使用环境		1~40℃		
清洗	出水量	臀部冲洗	0.40~0.79L/min	
		女性冲洗	0.40~0.79L/min	
	瞬时加热功率		1200W	
	清洗水温调节		五档可调(室温~39℃)	
	冲洗时间(最长)		300s	
	喷嘴数量		1	
	喷嘴位置调节		5档	
	脉冲按摩		开/关	
	移动冲洗		开/关	
	安全装置	水温过热保护	温度保险丝、过热断路器	
逆流防止		单向阀		
舒适	座圈保温	最大加热功率	40W	
		温度调节	五档可调(室温~39℃)	
		安全装置	温度保险丝、过热断路器	
	上盖		缓降	
	座圈		缓降	
	暖风	风机最大风量	0.19m ³ /min	
		最大加热功率	200W	
		温度调节	五档可调	
		安全装置	温度保险丝、过热断路器	
	除臭功能	风机最大风量	0.19m ³ /min	
卫生	喷嘴自清洗		有	
	快速拆除本体		推动释放键	
	抗菌材料		座圈、盖板	
	喷嘴UV杀菌		每天一次	
其它功能	控制面板		位于座圈侧面	
	落座感应		位于座圈内部	
	夜灯		2个蓝色LED灯	

谢谢您选择科勒公司

谢谢您选择科勒。科勒技术提供了可靠性能和优雅生活的结合，满足了您未来几年的需求。科勒产品的美观和可靠性将满足您最挑剔的眼光。我们为我们科勒的产品感到非常地自豪，相信您也会。

请花几分钟阅读一下这本用户手册，特别注意维护和清洗说明。

这本说明书中所有的信息基于最新公开的产品信息。在科勒，我们一贯坚持改善我们产品的质量。我们保留在任何时候不通知的情况下改变产品特性，包装或实用性的权利。

控制面板

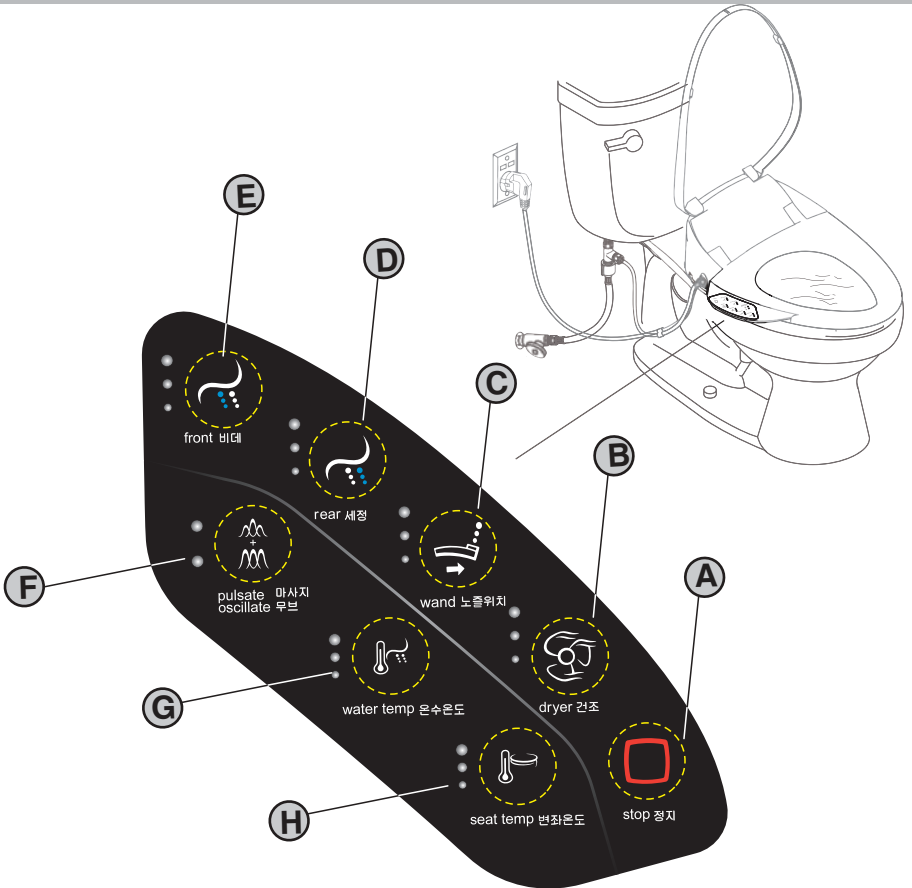

使用方法

□ A - 停止

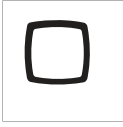

在冲洗或暖风开启时，按此键可停止冲洗或暖风功能。用户落座后，除臭功能自动开启。仅有除臭功能开启时，按停止键则关闭除臭功能。除臭功能关闭后，在重新落座前，将不再重新开启。



长按停止按键2秒，可关闭或打开夜灯，关闭时（长音），夜灯不亮；打开时（短音），夜灯受光线控制（外部光线暗则亮，反之则灭）。

□ B - 暖风



落座时，按暖风键启动暖风功能，如果此时正在使用冲洗功能，将被立即停止。

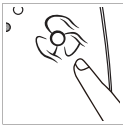

指示灯会显示当前的暖风温度，继续按暖风键，暖风温度按低档、中低档、中档、中高档、高档、中高档循环变化。连续工作约4分钟，该功能自动停止。

□ C - 喷管移动



在冲洗状态下，按喷管移动键后，启动喷管移动功能；继续按喷管移动键可改变喷管位置，位置按短距离、中短距离、中距离、中长距离、长距离、中长距离循环变化。

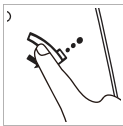

在无人落座情况下，长按喷管移动键2秒以上，喷管伸出。再次长按喷管移动键，喷管缩回。如果2分钟内无任何按键动作，喷管自动缩回。

□ D - 臀部冲洗



落座时，按臀部冲洗键，启动臀部冲洗，并显示现在的冲洗强度。如果此时正在使用暖风功能，将被立即停止。



在开启臀部冲洗功能的状态下，继续按臀部冲洗键可改变冲洗强度，强度按小档、小中档、中档、中大档、大档、中大档循环变化。连续冲洗约5分钟后，自动停止。

□ E - 女性冲洗



落座时，按女性冲洗键，启动女性冲洗（女性专用），并显示现在的冲洗强度。如此时正在使用暖风功能，将被立即停止。在开启女性冲洗功能的状态下，继续按女性冲洗键可改变冲洗强度，强度按小档、小中档、中档、中大档、大档、中大档循环变化。连续冲洗5分钟，自动停止。

□ F - 脉冲按摩+移动冲洗

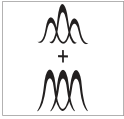

在冲洗状态下，按脉冲按摩/移动冲洗键后，启动脉冲按摩冲洗。

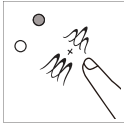

每次按键按脉冲按摩、移动冲洗、脉冲按摩+移动冲洗、关闭脉冲按摩+移动冲洗（返回女性冲洗或臀部冲洗）循环，并点亮相应的小灯。如果关闭脉冲按摩/移动冲洗（返回女性冲洗或臀部冲洗），指示灯不亮。

□ G - 水温



按水温键可设置冲洗水的温度，每次按键，按关、低档、中低档、中档、中高档、高档、中高档循环，设置冲洗水温，并切换点亮水温参数指示灯。如果是处于关闭状态，指示灯不亮。

□ H - 圈温



按座圈温度键可设置座圈温度，每次按键，按关、低档、中低档、中档、中高档、高档、中高档循环，设置座圈温度，并切换点亮圈温参数指示灯。如果是处于关闭状态，指示灯不亮。

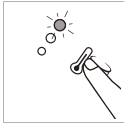

长按圈温按键2秒，可打开（短音）/关闭（长音）节能功能，圈温灯闪烁表示节能功能打开，圈温灯停止闪烁表示节能功能关闭。落座，则取消节能模式。开机后第一周，座圈自动检测用户使用习惯；从第二周开始，座圈根据上周检测到的用户使用频率，在频率低的期间内，自动进入节能状态；第三周再根据第二周检测到数据，自动判定节能状态，如此循环。

□ I - 档位说明

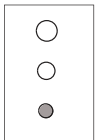

低档
小灯亮

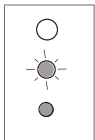

中低档
小灯亮，中
灯闪烁

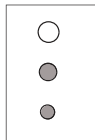

中档
小灯和中
灯同时亮

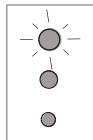

中高档
小灯和中灯亮，
大灯闪烁

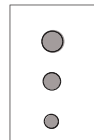

高档
小灯、中灯和
大灯同时亮

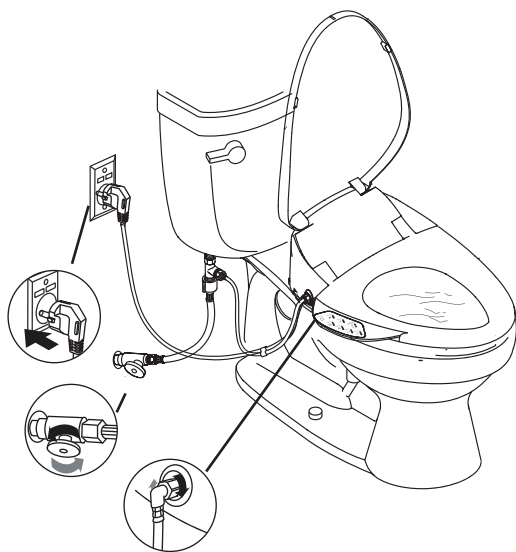

初次使用前准备

- 接上进水软管，打开止水阀，插上电源。
- 把电源线插上电源插座，座便盖发出短蜂鸣1次，喷管伸缩1次，侧键盘上背光灯点亮，夜灯闪烁，直至初始化结束。
- 初始化过程中，可听到电机转动声和流水声，均属正常。
- 初次使用时为出厂设置状态：

女性冲洗：	圈温：中档
• 水温：中档	风温：中档
• 水流强度：中档	夜灯：开
• 冲洗位置：中档	节能模式：关闭
臀部冲洗：	
• 水温：中档	
• 水流强度：中档	
• 冲洗位置：中档	



功能测试

- 用塑料布包裹着座圈上，防止测试时水从座便器中喷出。
- 座圈设计为落座感应模式。为了激活座圈达到测试的目的，首先面对座便器，然后把手或者一块湿布放在座圈右边离前端大约三分之一处（感应区域）。
- 继续参照“控制面板”和“使用方法”部分来测试座便盖的不同功能。

维护和清洗

为了达到最好的效果，在维护您的科勒产品时记住下列几条：

重要！不要用水直接冲洗座便盖。

- **测试** - 首先用清洗液在座便盖不显眼的地方测试，如果确认清洗液不会对座便盖外表造成损坏然后再应用于整个表面。

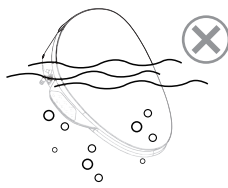

- **不要让清洁剂浸泡** - 不要让清洁剂浸泡产品。

- **避免表面粗糙的材料** - 使用柔软、潮湿的海绵或棉质布，不要用表面粗糙的材料来清洗表面，诸如刷子、冲刷垫等。

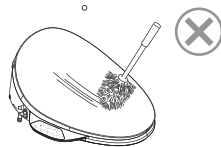

- **擦洗** - 加上清洁剂后，立即用湿布擦洗表面，擦除喷到表面的清洁剂和脏物。

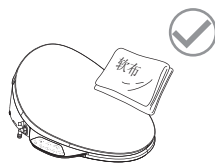

清洗座圈

- 在气雾罐中避免有研磨的清洁剂和消毒剂。



维护提示：用洗涤剂和水混合液体或任何列为可用于座圈清洁的产品清洗座圈，用柔软湿润的海绵或者布。用软毛巾擦干，在空气中让座圈自然干燥。

- 不允许带腐蚀的化学品或化妆品（诸如指甲油或须后水）和座圈接触，避免破坏表面。



注意：不遵守这些清洗说明可能使科勒的保修义务无效。

注意：清洗程序的成功取决于诸如水的硬度和温度，使用成分的精确数量，清洗规则的改变和被清洗产品的状态等因素。因为这些因素会有变化，科勒不能保证所提到的规则的有效性。

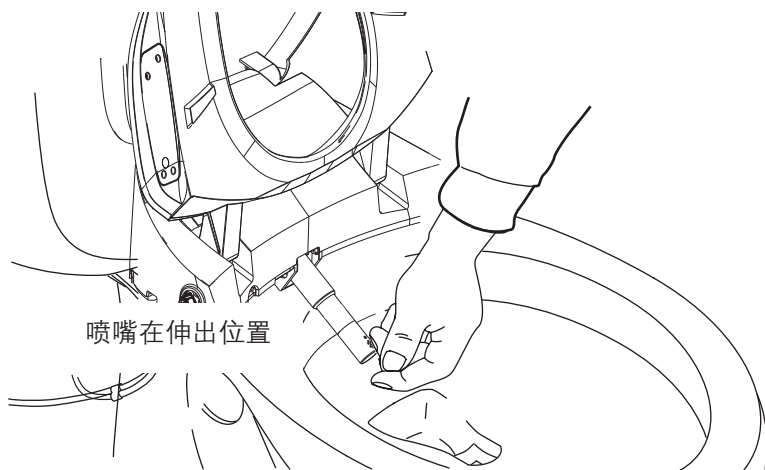

喷嘴在伸出位置

清洗喷嘴

注意：当座便盖不被使用或启动的时候，喷嘴才能伸出以便清洗。

- 翻开上盖和座圈。
- 长按喷管移动键2秒以上，待喷管完全伸出后，用软鬃毛刷清洗喷嘴。
- 喷嘴清洗完毕后，长按喷管移动键2秒以上，喷管缩回，或等待喷管自动缩回。

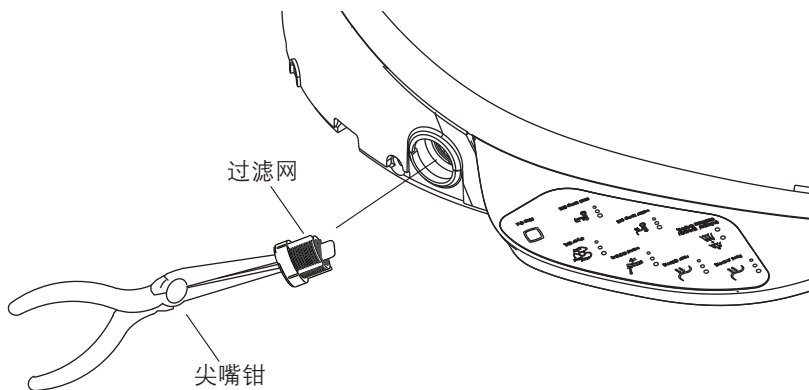

清洗过滤网

重要！产品损坏的危险。小心不要造成接头损坏。

- 关闭供水阀。
- 卸下座便盖供水管。
- 用尖嘴钳小心的将过滤网从产品的进水口移出（见图示）。
- 用软鬃毛刷清洗过滤网。
- 重新装好过滤网。
- 小心对正螺纹，重新装好座便盖的供水管。
- 为防泄漏，请检查所有的连接，并做必要调整。
- 开启供水阀门。

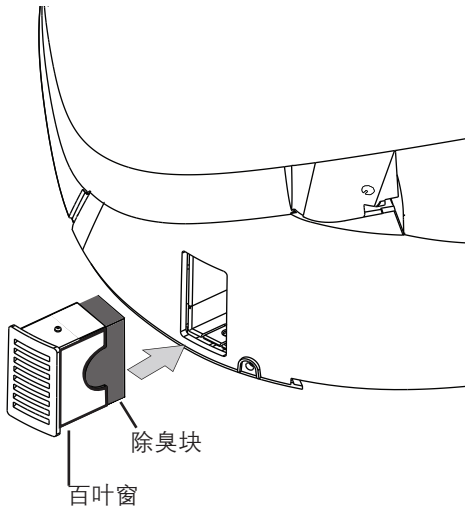

更换除臭块

重要！产品损坏的危险。拆卸百叶窗时不能用力太大，否则可能损坏百叶窗。

- 从产品侧面将百叶窗取下。
- 用手指夹住除臭块，向外拉出。
- 重新装入新的除臭块。
- 重新装上百叶窗。
- 安装新除臭块前先检查是否有异物留存在管内，如有需要提起产品前端使异物掉出风管。

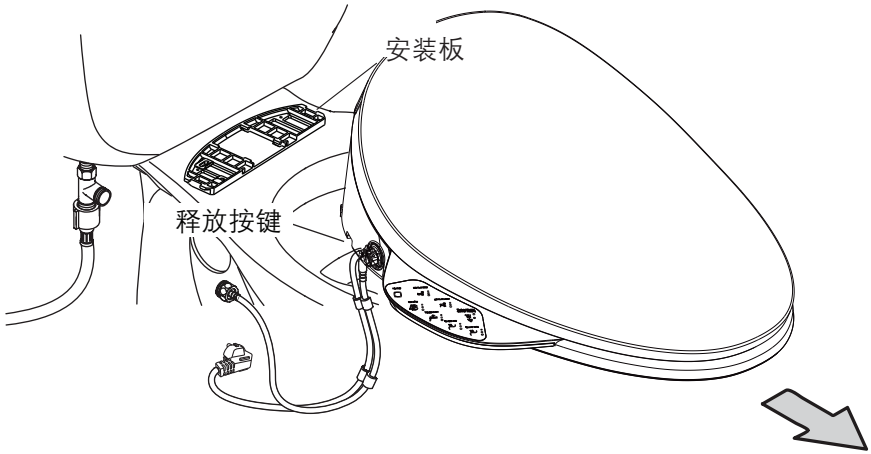

移除座便盖

- 关闭供水阀。
- 开启座便器冲洗功能减轻供水管压力。
- 拔掉座便盖电源插头。
- 断开供水管和三通连接。
- 按释放按键（见图示）。
- 向前移动座便盖，使座便盖和安装板分离。

注意：座便盖可能会有水，是否被排放完全，详情参见“座便盖排水”。

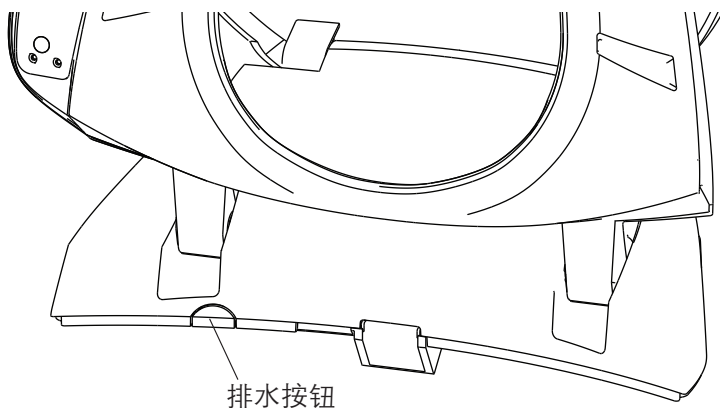

座便盖排水



警告：产品损坏的危险。当座便盖长期不使用，或环境温度有可能降低到冰点以下时，应事先排尽座便盖管路中的残留水。

- 切断供水，拔下插头。
- 从座便器上拆下座便盖，参考“移除座便盖”部分。
- 按压排水按钮。
- 从座便盖中把水排除。

疑难解答

这份疑难解答只提供普通帮助。科勒授权的服务代表能解决相关的电气问题。保修服务方面的问题，请联系你的经销商或批发商。

疑难解答 (续)

一般功能

故障现象	可能原因	建议措施
1. 机器不工作	<p>A. 停电</p> <p>B. 未接上电源线。</p> <p>C. 电源线漏电插头保护开关未复位。</p> <p>D. 人体未接触座圈感应区域。</p> <p>E. 热保护器开启自动保护。</p> <p>F. 以上措施都不见效。</p>	<p>A. 等到电力恢复。</p> <p>B. 将插头插在插座上。</p> <p>C. 按下插头上的复位按钮。</p> <p>D. 接触座圈感应区域。</p> <p>E. 将产品在室温环境下静置一段时间。</p> <p>F. 联系科勒服务代表。</p>
2. 座圈松动。	<p>A. 螺丝和螺母未拧紧。</p>	<p>A. 依据安装指导拧紧螺丝和螺母。</p>
3. 喷管不能出水。	<p>A. 座圈未能感应到使用者。</p> <p>B. 供水阀关闭。</p> <p>C. 过滤网阻塞。</p> <p>D. 以上措施都不见效。</p>	<p>A. 调整坐姿。皮肤与座圈之间不能有物体隔离，如裤子等。</p> <p>B. 关闭电源，排除供水故障,重新通电</p> <p>C. 查看“清洗过滤网”部分。</p> <p>D. 联系科勒服务代表。</p>

清洁功能

故障现象	可能原因	建议措施
4. 无水流。	<p>A. 供水阀已关。</p> <p>B. 落座感应器没有探测到使用者。</p>	<p>A. 打开供水阀。</p> <p>B. 在“功能测试”部分查看激活座圈信息。</p>
5. 冲洗水压小。	<p>A. 过滤网阻塞。</p> <p>B. 供水水压不足。</p>	<p>A. 查看“清洗过滤网”部分。</p> <p>B. 提高水压到产品要求的水压范围。</p>
6. 完成清洗前水就停止从喷嘴中喷出。	<p>A. 连续冲洗5分钟，冲洗功能自动停止。</p> <p>B. 落座感应器没有探测到使用者。</p>	<p>A. 如需要，请再次按下冲洗按键。</p> <p>B. 在“功能测试”部分查看激活座圈信息。</p>
7. 冲洗时有水从喷嘴旁边的孔中流出。	<p>A. 产品内部防止水压过高的保护。</p>	<p>A. 正常现象。</p>

疑难解答 (续)		
8. 落座时, 有水从喷嘴处流出。	A. 长时间无人使用时, 将在使用前自动排放喷管内部的残留水。	A. 正常现象。
座圈缓降		
故障现象	可能原因	建议措施
9. 座圈和盖板的关闭速度在夏季和冬季有所不同。	A. 因室内温度变化。	A. 正常现象。
落座感应器		
故障现象	可能原因	建议措施
10. 不使用时按下清洗按键, 清洗功能启用。	A. 落座感应器被物体覆盖或座位是湿的。	A. 擦拭落座感应器区域的水或异物。
11. 即使坐着, 清洗功能也不起作用。	A. 当前的坐姿, 落座感应器不能检测到使用者。	A. 变换坐的姿势。
暖风功能		
故障现象	可能原因	建议措施
12. 使用过程中暖风风机停止工作。	A. 连续使用烘干功能4分中, 风机自动停止。	A. 再次按暖风按键。
除臭功能		
故障现象	可能原因	建议措施
13. 除臭风机不工作。	A. 落座感应器没有探测到使用者。 B. 误按下停止键。	A. 在“功能测试”部分查看激活座圈信息。 B. 在“使用方法”部分查看激活座圈信息。
14. 气味未消除。	A. 除臭块因使用过久而失效。 B. 某些人对气味特别敏感。	A. 更换除臭块。 B. 无
其他		
故障现象	可能原因	建议措施
15. 产品松动。	A. 固定产品的安装板的螺丝松动。	A. 拧紧安装板螺丝。

维修零件图 K-4107KR

1185019-SP
安装螺丝附件包



1102014-SP
线夹附件包



1184968-SP
缓冲垫



1183663-SP
基本型喷嘴组件



1085189-SP
进水附件包



1185010-SP
气泵组件



1186590-SP
干燥风机



1085187-SP
三通



1205727-SP
电源线



1185002-SP
进水阀组件



1186595-SP
侧键盘电路板



1207946-SP
键盘面板贴膜(按键)



1194769-SP
座圈缓冲垫组件

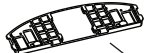

1185018-SP
安装板组件



1185006-SP
缓冲水箱组件

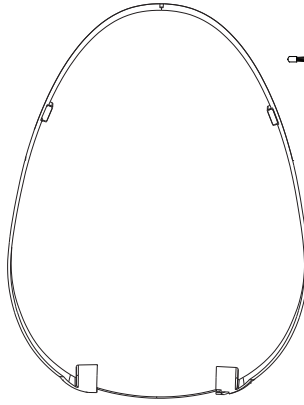

1186587-SP
LED夜灯线束

1185014-SP-
上盖组件



1184962-SP-
除臭百叶窗

1185012-SP
除臭组件

1184969-SP
进水阀滤网

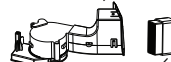

1150820-SP
脱臭块(触媒型)

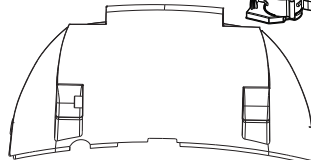

1185016-SP
上盖阻尼组件

1185015-SP
座圈阻尼组件



1205946-SP
主控模块组件



1185004-SP
加热组件

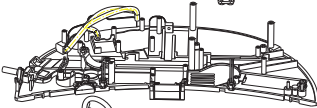

1185003-SP
流量计组件

1194770-SP
分配器喷管组件



1186150-SP
电源模块组件



1182246-SP
驱动模块组件
(220V)

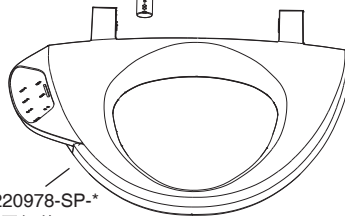

1220978-SP-
座圈组件



1185011-SP
暖风组件

*订购时请说明颜色编号。

三年有限担保

科勒担保本厨卫产品在正常家用的情况下自购买之日起三年内无材料及制造工艺上的瑕疵。本担保仅适用于在下列国家/地区购买并安装的厨卫产品。

在担保期内，如发现产品在正常家用的情况下存在瑕疵，经核查后，科勒将自行决定对产品进行修理、更换、或是作适当的调整。科勒不承担上述成本以外的人工成本、拆除或安装的成本，或其他附带的或衍生性的支出。

如产品被用于商业目的，则科勒担保该产品自购买之日起一年内无材料及制造工艺上的瑕疵。除担保期限以外，本担保的其他条款均适用。

产品的默示担保（包括对产品的适销性和适用于特定目的的担保）仅限于担保期内有效，并且科勒对任何特殊、附带或衍生性损害赔偿不承担责任。

有些国家/地区不允许限定担保期或对特殊、附带或衍生性损害赔偿进行排除或限制，所以上述限制和排除可能对您不适用。本担保赋予您明确的法律权利。您可能还享有其他权利，该等权利因国家/地区的不同而有所区别。本担保仅适用于原购客户。由于意外、安装错误、误用或使用不当造成的产品损害不属于担保范围之内。不适当的保养和清洁将导致担保无效。

为获得担保服务，请联系您的经销商或承包商，或联系下列科勒服务中心。请确保提供所有相关的信息，包括完整的问题描述、型号、颜色、表面镀层、购买时间及销售方。请务必同时提供购买凭证（原销售发票）。

各产品购买地区/国家科勒担保服务中心

产品购买地区/国家

地址

中国大陆

科勒（中国）投资有限公司
中央客户服务中心
中国上海市闸北区江场三路158号
邮编：200436
免费咨询保修电话： + (86) 800-820-2628
400-820-2628

泰国

Kohler (Thailand) Public Company Limited
16 FL. Jasmine City Bldg., 2 Sukhumvit 23,
Wattana, Bangkok, Thailand. 10110
电话: +(66) 2204 6222
传真: +(66) 2204 6224
E-mail: callcenterthailand@kohler.com

香港, 澳门和台湾

科勒亚洲有限公司
香港湾仔骆克道188号兆安中心29/F
电话: +(852) 3125 7728
传真: +(852) 2802 2162

新加坡、菲律宾、
马来西亚、印度尼西亚、
越南、韩国、
文莱和日本

亚洲客户服务中心
中国上海市闸北区江场三路158号
邮编: 200436
电话: +(86) 21 2606 2572
传真: +(86) 21 6107 8900

这是我们全部的书面担保!

중요 안전 정보

이 설명서를 잘 보관하시기 바랍니다.



경고: 전기 충격, 화재, 상해의 위험

GFCI(Ground-Fault Circuit-Interrupter) 또는 ELCB(Earth Leakage Circuit-Breaker)가 보호하는 정격 220-240V AC, 50/60Hz, 10A 회로에만 연결하십시오. 콘센트를 다른 기구와 동시에 사용하거나, 연장 코드를 사용하면 화재, 감전의 원인이 됩니다.



경고: 감전 및 제품 손상의 위험

제품을 물 속에 담그거나 물로 씻어서는 안됩니다.

중요! 제품 손상의 위험

제품에 물이 될 수 있는 곳에 설치해서는 안됩니다.

중요! 제품 손상의 위험

제품에 물을 뿌리거나 습기가 많은 장소에는 설치 하지 마십시오.(화장실 전용 제품이므로 절대 다른 용도로 사용을 금해 주십시오) 감전, 누전, 화재의 원인이 됩니다.

중요! 제품 손상 및 재산 피해의 위험

본체 급수호스를 무리하게 잡아당기거나 힘을 가하지 마십시오. 누수의 원인이 됩니다.

중요! 제품 손상의 위험

제품 고장의 위험이 있으므로 노즐에 무리하게 힘을 가하지 마십시오.

중요! 제품 손상의 위험

기온이 영하로 내려갔을 경우에 급수 호스에 보온 조치를 하여, 급수 호스가 결빙되지 않도록 합니다. 다시 설치하거나 사용할 때 제품을 실내온도와 같게 유지시켜 주십시오.

중요! 제품 손상의 위험

제품에 고장이 생길 수 있으므로, 설치가 끝나기 전에 전원을 연결하지 마십시오.

주의: 여름에는 과열방지장치가 효과를 상실하여 제품이 작동하지 않을 수 있습니다. 다시 설치하거나 사용할 때 제품을 실내 온도와 같게 유지시켜 주십시오.

특히 어린이가 제품을 사용할 경우, 반드시 안전수칙을 준수하기 바랍니다.

위험 - 기본 안전 수칙 :

- 제품을 떨어뜨릴 수 있거나, 욕조 등 물에 빠질 위험이 있는 곳에 놓지 마십시오.
- 물이나 다른 액체를 떨어뜨리지 않도록 주의 하십시오.
- 물에 떨어진 제품과 접촉하지 말고 플러그를 즉시 뽑으십시오.

경고 - 화상, 감전, 화재, 상해의 위험:

- 어린이, 노인, 환자가 제품을 사용할 때는 세심한 주의가 필요합니다. 기능을 숙지 시킨 후 제품을 사용하게 하십시오.
- 스스로 온도를 조절할 수 없는 어린이와 노약자를 위해, 변기의 온도, 물, 바람을 적절한 수준으로 조정해 줄 필요가 있습니다.
- 사용설명서에 기재된 목적을 위해서만 본 제품을 사용하십시오. Kohler에서 권하지 않는 부속을 사용하지 않도록 주의 하십시오.
- 제품을 사용할 때 시트 커버에 기대지 마십시오.
- 코드나 플러그에 문제가 있거나, 제대로 작동하지 않거나, 떨어져서 고장이 났거나 물에 빠진 경우에는 본 제품을 작동해서는 안됩니다.
- 설치 과정에 따라 제품을 설치해 주시기 바랍니다.
- 본 제품은 전문가가 설치하고 수리해야 합니다. 사용자가 직접 제품을 수리하시면 품질 보증을 받으실 수 없습니다.
- 코드를 고열 물체에서 접촉하지 마십시오.
- 틈이나 호스 속에 물체를 넣거나 떨어뜨리지 마십시오.
- 실외 혹은 에어로졸 스프레이가 사용되는 곳에서 제품 사용을 삼가 주십시오.
- 플러그를 꽂기 전에 본 설명서의 지시에 따르기 바랍니다.
- 전원 플러그에 물을 뿌리지 마십시오.
- 화상의 피해를 막기 위해 가열된 시트에 장시간 앉아 있는 것을 삼가해 주시기 바랍니다.
- 전원 코드에 문제가 발생하게 되면, 구입처에 문의 하시기 바랍니다.

사양

사용급수압		0.7kgf/cm ² (동압)~ 7.5 kgf/cm ² (0.07MPa.(동압)~ 0.74MPa.)		
정격 / 최대소비전력		220~240V AC 50/60Hz 1200W		
전원코드 길이		약1.5m		
제품크기		521mm x 435mm x 157mm		
제품중량		약3.0Kg		
사용환경		1~40℃		
세정기능	토수량	세정	0.40~0.79L/min	
		비데	0.40~0.79L/min	
	히터용량		1200W	
	온도조절		5단계 조절 가능(실온 ~ 39℃)	
	분무시간(최대)		300s	
	노즐개수		1	
	노즐위치조절		5단계 조절	
	마사지 세정		On/Off	
	무브 세정		On/Off	
	안전장치	과열방지	온도퓨즈, 썸머 차단기	
역류방지		체크밸브		
쾌적기능	시트	히터용량	40W	
		온도조절	5단계 조절 가능(실온 ~ 39℃)	
		안전장치	온도퓨즈, 썸머 차단기	
	시트 커버		소프트 개폐	
	시트		소프트 개폐	
	건조	건조팬 용량	최대히터용량	200W
			온도조절	5단계 조절 가능
			안전장치	온도퓨즈, 썸머 차단기
탈취팬 용량			0.19m ³ /min	
탈취	탈취팬 용량	0.19m ³ /min		
위생기능	자동 노즐 세정		유	
	신속개폐		누름버튼으로 작동되는 레버	
	항균 재질		시트, 시트 커버	
	노즐UV살균		하루에 한번	

사양 (계속):

기타기능	조작부	변좌 측면에 위치
	착좌 센서	변좌 내부에 위치
	야간 램프	2개의 Blue LED – Auto On/Off

Kohler Company 제품을 구입해 주셔서 감사합니다.

Kohler의 제품을 선택해 주셔서 감사드립니다. Kohler는 앞으로 오랫동안 사용자에게 만족할 만한 성능을 드릴 것입니다. Kohler는 제품에 대한 자부심을 가지고 사용자에게 다가가겠습니다.

제품의 안전하고 올바른 사용을 위해 본 사용설명서를 숙지해 주시기 바랍니다. 특히 관리와 청결에 관한 부분에 대한 주의를 기울여 주시기 바랍니다.

본 사용설명서에 있는 모든 정보는 최신 제품 정보를 기본으로 합니다. Kohler는 제품의 질을 향상시키기 위해 끊임없이 노력하고 있습니다. 당사는 사전 예고 없이 언제든지 제품 특징, 포장, 이용에 관한 변경 권한을 가지고 있습니다.

조작부

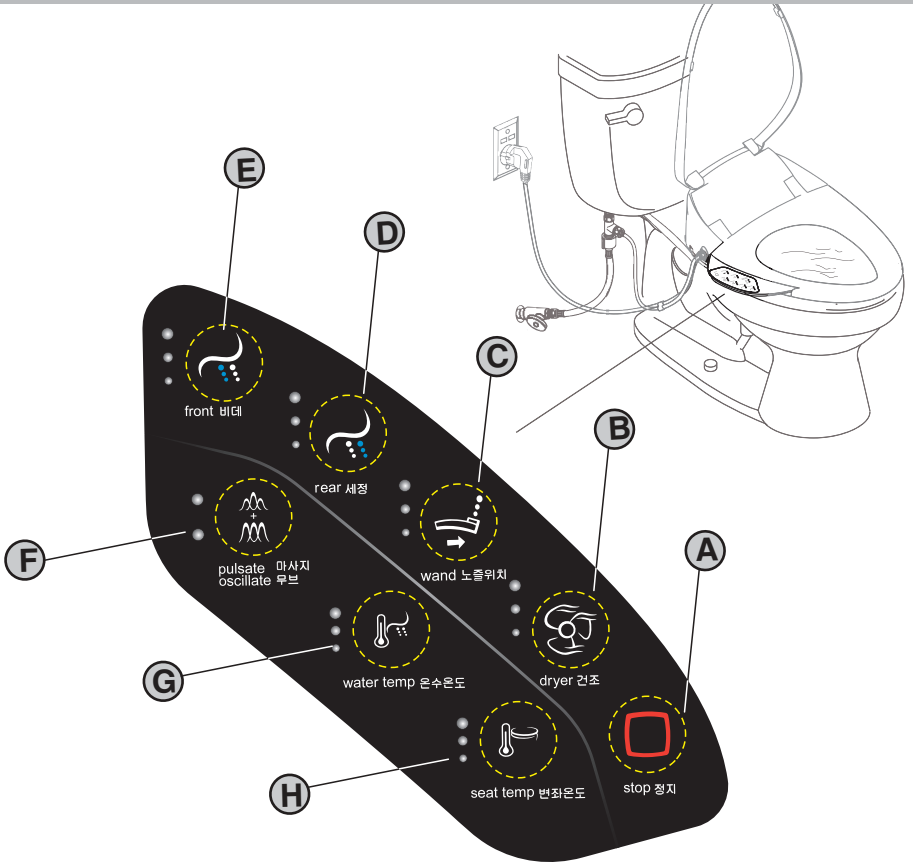

사용방법

□ A - 정지

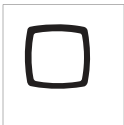

세정이나 건조 기능을 사용 하였을 때, 정지 버튼을 누르면 세정과 건조기능을 정지 시킬 수 있습니다. 사용자가 착석하면 탈취기능이 자동으로 작동합니다. 탈취기능이 작동된 후에 정지 버튼을 누르면 탈취기능이 멈춥니다. 탈취기능을 정지한 후 다시 착석하기 전에는 이 기능은 작동 하지 않습니다.



정지버튼을 2초 동안 누르면, 야간램프를 작동시키거나 정지시킬 수 있습니다. 정지 시(긴벨) 조명이 꺼지며, 작동 시(짧은벨) 외부 광선의 제어로 램프기능이 자동으로 실행됨을 의미합니다. (외부가 어두우면 야간 조명이 작동하고, 외부가 밝으면 작동하지 않습니다)

□ B - 건조



착석 후, 건조 버튼을 눌러 건조 기능을 작동시키는데, 이때 만약 세정 기능을 사용하고 있다면 세정 기능은 정지됩니다.

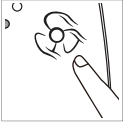

램프는 현재 건조의 온도를 나타내며, 계속 건조 버튼을 누르면 건조 온도는 5단계 조절이 가능하며, 연속 4분 작동하고 나서 자동으로 멈춥니다.

□ C - 노즐 위치



세정 기능 사용시, 노즐 위치 버튼을 눌러 노즐 이동 기능을 작동시킵니다. 노즐 이동 버튼을 지속적으로 눌러주면 노즐 위치는 5단계로 이동이 가능합니다.

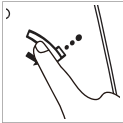

사람이 착석하지 않은 상황에서 노즐 위치 버튼을 2초 이상 누르면 노즐이 신장됩니다. 다시 노즐 위치 버튼을 2초 이상 누르면 노즐이 들어갑니다. 만약 2분 내에 아무 버튼도 누르지 않았다면 노즐이 자동으로 들어갑니다.

□ D - 세정



착석시, 세정 버튼을 누르면 세정 기능이 작동하며 세정 강도가 나타납니다. 이때 만약 건조 기능을 사용하고 있다면 건조 기능은 정지됩니다.



세정 기능 작동시, 계속 세정 버튼을 누르면 세정의 단계가 변합니다. 세정의 단계는 5단계로 변화하며, 연속 5분간 작동 시 자동으로 정지합니다.

□ E - 비데



착석 시, 비데 버튼을 누르면 비데 기능(여성성용)이 작동하고 비데 단계가 나타납니다. 이때 만약 건조 기능을 사용하고 있다면 건조 기능은 정지됩니다. 비데 건조 작동 시, 계속 비데 버튼을 누르면 비데의 단계가 변합니다. 비데의 단계는 5단계로 변화하며, 연속 5분 작동 시 자동으로 정지합니다.

□ F - 마사지 & 무브

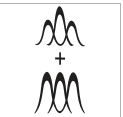

세정 기능 작동 시, 마사지 버튼을 누르면 마사지 기능이 작동합니다.



매번 버튼을 누르면 마사지 세정, 무브 세정, 마사지 / 무브 세정, 마사지 / 무브 세정 정지(비데 혹은 세정으로 복귀)로 연속 작동되며 해당 램프가 점등됩니다. 마사지 / 무브 세정 정지(비데 혹은 세정으로 복귀) 상태일 경우 램프는 켜지지 않습니다.

□ G - 온수 온도



세정 기능 작동 시에 온수 온도 버튼을 누르면 수온을 5단계로 조절 할 수 있습니다. 수온이 조절되면 해당 수온 램프가 켜집니다. 만약 꺼져있는 상태라면 램프는 켜지지 않습니다.

□ H - 변화 온도



변화 온도 버튼을 누르면 변화 온도를 5단계로 조절할 수 있으며, 그에 맞는 시트 온도 램프가 켜집니다. 만약 꺼져있는 상태라면 램프는 켜지지 않습니다.

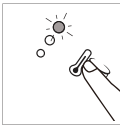

변화 온도 버튼을 2초 이상 누르면, On(짧은벨) / Off(긴벨) 기능을 작동할 수 있고, 온도 램프가 깜빡이면 에너지 절약기능이 작동 되었음을 나타내고, 램프가 깜빡이는 것을 멈추면 에너지 절약 기능이 끝난 것을 의미합니다. 착석하면 에너지 절약 기능이 취소됩니다. 비데 사용 후 1주차에 비데는 자동으로 사용자의 사용 습관을 학습합니다. 2주차에는 1주차에 학습된 사용자의 사용빈도에 따라 사용빈도가 가장 낮은 시간대에 절전상태가 되도록 자동입력이 됩니다. 3주차에는 1, 2주차의 데이터에 의해 자동으로 절전상태를 결정하게 됩니다. 그 이후부터는 같은 방식으로 반복됩니다.

□ I - 단계 설명

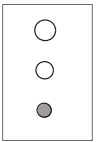

1 단계

작은 램프가 켜집니다.

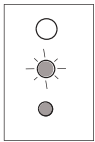

2 단계

작은 램프가 켜지고 중간 램프가 깜빡입니다.

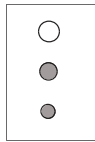

3 단계

작은 램프와 중간 램프가 동시에 켜집니다.

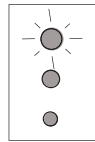

4 단계

작은 램프와 중간 램프가 켜지고 큰 램프가 깜빡입니다.

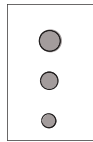

5 단계

작은 램프, 중간 램프, 큰 램프가 동시에 켜집니다.

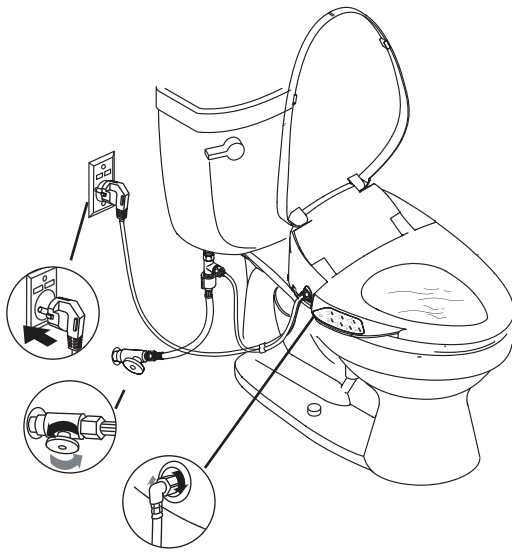

처음 사용시 준비 사항

- 급수호스를 연결하고 급수 밸브를 열고 전원을 콘센트에 연결합니다.
- 전원을 콘센트에 연결하여, 비데에서 벨소리가 한번 나고, 노즐이 한번 신장되고, 조작부 램프가 켜지고, 야간 조명이 반짝이면 초기화가 완료된 것입니다.
- 초기화 과정에서 모터 회전 소리와 물 소리가 들리는 현상은 모두 정상 작동입니다.
- 처음 사용시의 설정 상태 :

비데:	변좌온도:중급
• 위치:중급	건조온도:중급
• 수압:중급	야간조명:On
• 수온:중급	에너지 절약 모드:Off
세정:	
• 위치:중급	
• 수압:중급	
• 수온:중급	



기능 테스트

- 비닐로 변좌 시트를 감싸고 테스트를 진행하여, 제품에 물이 튀는 것을 방지합니다.
- 비데는 착좌 센서로 작동하며, 테스트하기 위해서는 먼저 손 혹은 젖은 수건으로 시트의 오른쪽으로부터 앞부분의 1/3되는 곳(감지영역)에 놓습니다.
- 조작부와 사용방법을 참조하여 각각의 기능을 테스트합니다.

유지와 청결

주의 사항

- ⚠️ **중요!** 물로 비데를 직접 씻지 마십시오.
- 테스트-먼저 세정액으로 눈에 잘 띄지 않는 곳을 세척하여, 손상되지 않으면 사용하셔도 됩니다.
- 세제 속에 제품을 담그거나 과도하게 접촉하지 마십시오.
- 거친 재료의 청소 도구의 사용을 삼가 해야 합니다. 부드러운 재료의 청소 도구를 사용하여 청소하며, 거친 재료의 도구로 제품을 닦지 말아야 합니다. 예) 세정솔 등
- 닦기-세정제를 사용한 후에는 즉시 젖은 수건으로 닦아내야 하며, 젖은 수건으로 제품 표면에 튀긴 오물을 닦아 냅니다.

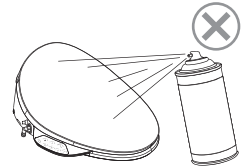
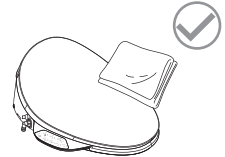
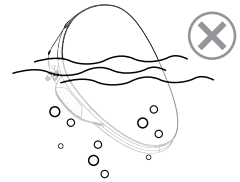

시트 청소

- 제품에 손상을 줄 수 있는 세정액이나 소독액을 사용해서는 안됩니다.

유지 방법 : 시트 세정이 가능한 세정액으로 시트를 청소하며, 젖은 수건으로 물기를 닦고 자연스럽게 건조를 시킵니다.

- 부식성분이 있는 화학품이나 화장품(아세톤 혹은 애프터 셰이브 스킨)을 사용하여 제품 표면을 부식시키는 것을 피해야 합니다.



⚠️ 주의 : 위의 청결 유지 방법을 준수하지 않으면 제품 보증기간이 보장되지 않을 수 있습니다.

⚠️ 주의 : 물속의 칼슘, 마그네슘 함유 정도에 따라 청결 상태가 결정되며, 이러한 요소가 변하게 되면, 콜러가 제시한 성능을 보장 할 수 없습니다.

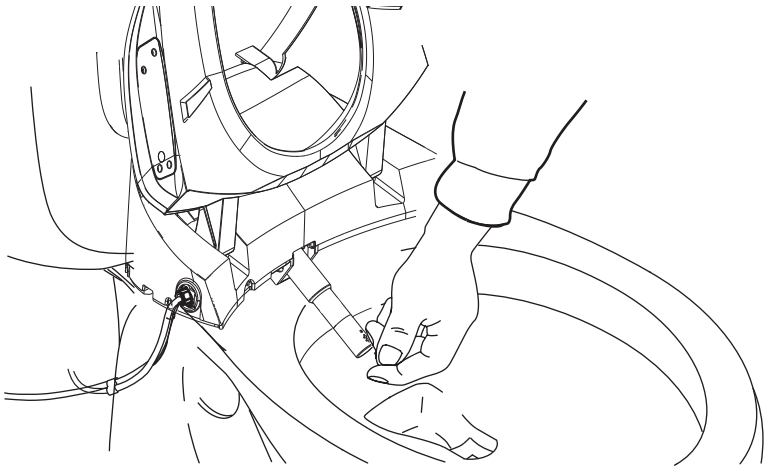

노즐 청소

주의 : 비데를 사용하지 않을 때 노즐을 신장시켜 청소가 가능합니다.

- 시트 덮개와 변좌 시트를 올립니다.
- 노즐 위치 이동 버튼을 2초 이상 오래 눌러서 노즐을 완전히 신장 시킨 상태에서 부드러운 솔로 청소합니다.
- 노즐을 청소한 뒤, 노즐 이동 버튼을 2초 이상 눌러 노즐을 들어가게 합니다. 노즐 이동 버튼을 누르지 않으면, 노즐은 일정 시간 이후 자동으로 들어가게 됩니다.

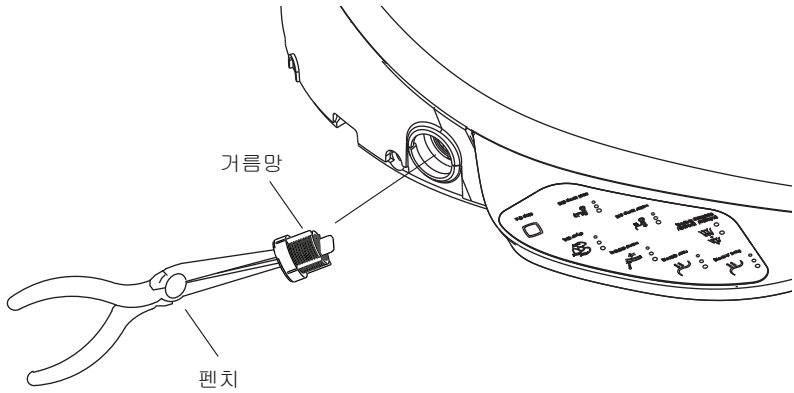

거름망 청소

중요! 제품손상의 위험, 연결부분에 손상이 가지 않도록 주의해야 합니다.

- 급수밸브를 잠급니다.
- 비데의 급수관을 분리합니다.
- 펜치로 조심스럽게 필터를 제품으로부터 분리합니다.(그림 참조)
- 부드러운 솔로 거름망을 청소합니다.
- 거름망을 재설치 합니다.
- 나사선을 맞춰, 비데의 급수관을 다시 연결합니다.
- 누수를 예방하기 위해 모든 연결 부분을 확인합니다.
- 급수밸브를 작동 시킵니다.

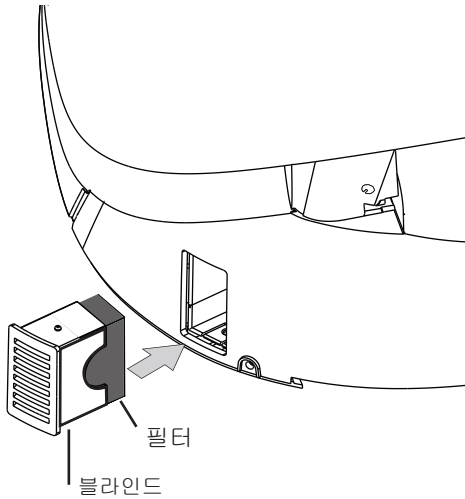

탈취 블록 교체

중요! 제품손상의 위험. 블라인드를 분리 할 때 힘을 무리하게 주면 블라인드를 손상시킬 수 있습니다.

- 제품 측면에 있는 필터를 분리합니다.
- 손으로 탈취 블록을 밖으로 빼냅니다.
- 탈취 블록을 새 것으로 교체합니다.
- 필터를 재설치 합니다.
- 탈취 블록을 새로 설치하기 전에 이물질이 탈취 조립부에 끼지 않도록 확인해야 하며, 만약 있다면 제품의 앞부분을 들어서 빠져 나오게 합니다.

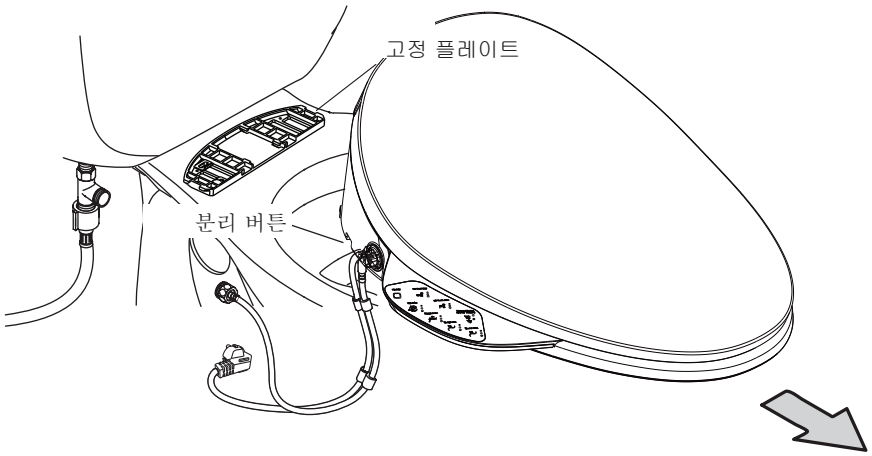

비데 본체 분리

- 입수 밸브를 잠급니다.
- 비데의 세정기능을 작동하여 급수관의 압력을 줄입니다.
- 전원 플러그를 뽑습니다.
- 급수관과 T-밸브를 분리 합니다.
- 분리 버튼을 누릅니다.(그림참조)
- 비데를 앞으로 이동시켜, 비데와 고정플레이트를 분리 시킵니다.

주의: 비데에 물이 있을 수 있으므로 “비데의 배수” 를 참고하여, 깨끗하게 배출 되었는지를 확인합니다.

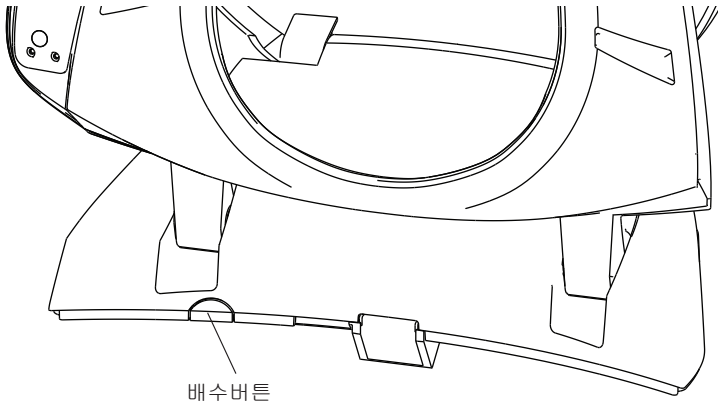

비데의 배수



경고: 제품손상의 위험. 비데를 오랫동안 쓰지 않을 경우 혹은 사용환경의 온도가 결빙점 이하로 내려갈 가능성이 있을 경우, 사전에 먼저 비데 급수호스의 물을 깨끗하게 배수해야 합니다.

- 급수를 정지하고 플러그를 뽑습니다.
- “비데 분리” 부분을 참고하여, 변기에서 비데를 분리합니다.
- 배수버튼을 누릅니다.
- 비데의 물을 배수합니다.

고장 해결

제품에 문제가 있을 시, 서비스 관련 문의는 구입하신 콜러 대리점에 연락하시기 바랍니다.

일반적인 기능

증상	가능한 원인	처리 방법
1. 작동하지 않는다.	A. 정전 B. 전원선에 연결되지 않았습니 C. 누전 차단기가 동작하지 않 D. 신체가 시트의 감지영역에 닿지 E. 과열방지장치가 자동으로 켜져 F. 이상의 조치가 모두 효과를 보지	A. 전력이 회복하기를 기다립니다. B. 플러그를 콘센트에 꽂습니다. C. 전원 플러그를 뺀다 다시 연결하 D. 시트 감지 영역 내부에 앉아야 E. 제품이 과열되어 있다면 실내 F. 구입하신 콜러 대리점에
2. 시트가 느슨해 졌습니 다.	A. 볼트와 너트가 조여지지 않았습니 다.	A. 설치방법에 따라 볼트와 너트를 다시 조입니다.
3. 노즐에서 물이 나오지 않습니 다.	A. 센서가 사용자를 감지하지 B. 급수밸브가 잠겨 있습니다. C. 거름망이 막혔습니 D. 이상의 조치가 모두 효과를 보지	A. 앓는 자세를 조절합니다. 피부와 B. 전원을 끄고, 급수 밸브를 열고, C. “거름망 청소”부분을 살펴 D. 구입하신 콜러 대리점에

청소 기능

증상	가능한 원인	처리 방법
4. 물이 공급 되지 않습니 다.	A. 급수밸브가 닫혔습니 B. 착좌 센서가 사용자를 감지하지 C. 거름망이 막혔습니	A. 급수밸브를 엽니다. B. “기능 테스트”부분을 살펴 C. “거름망 청소”부분을 살펴
5. 물세기가 약합니다.	A. 거름망이 막혔습니 B. 급수 수압이 약합니다	A. “거름망 청소”부분을 살펴 B. 수압을 가능 범위까지 높입니다.
6. 세정기능이 끝나기 전에 노즐에서 물이 나오지 않습니 다.	A. 연속 5분 세정을 하면 세정기능 B. 착좌 센서가 사용자를 감지하지 C. 거름망이 막혔습니	A. 필요하다면 다시 한번 세정 또는 B. “기능테스트” 부분을 살펴 C. “거름망 청소”부분을 살펴
7. 세정할때 물이 노즐옆의 흠에서 나옵니다.	A. 제품 자체가 수압이 너무 높은것을 방지하기 위한 보호입니다.	A. 정상현상입니다.

8.착좌시 노즐에서 물이 새어 나옵니다.	A.장기간 사용하지 않고 나서 다시 사용할때, 노즐내의 잔류물은 자동으로 배수됩니다.	A. 정상현상입니다.
------------------------	---	-------------

소프트 커버

증상	가능한 원인	처리 방법
9.시트와 시트 커버의 개폐속도가 여름철과 겨울철이 다릅니다.	A.실내온도의 변화때문입니다.	A. 정상현상입니다.

착좌 센서

증상	가능한 원인	처리 방법
10.사용하지 않을때에도 세정 버튼을 누르면 기능이 작동합니다.	A.착좌 센서가 물건에 의해 덮혀 있거나 물에 젖어 있습니다.	A.착좌 감지 영역에 물건을 놓지 말고 물기를 닦습니다.
11.착석시에도 세정 기능이 작동하지 않습니다.	A.앉는 자세에 따라 착좌센서가 사용자를 감지하지 못합니다.	A.앉는 자세를 바꿉니다.

건조 기능

증상	가능한 원인	처리 방법
12.사용 중 건조 기능이 멈춥니다.	A.연속4분 건조기능을 사용하면 자동으로 정지합니다.	A.건조버튼을 다시 누릅니다.

탈취 기능

증상	가능한 원인	처리 방법
13.탈취 기능이 작동하지 않습니다.	A.착좌 센서가 사용자를 감지하지 못합니다. B.정지버튼을 잘못 눌렀습니다.	A."기능테스트" 부분을 살펴 봅니다. B."사용방법"부분을 살펴봅니다.
14.냄새가 남아있습니다.	A. 탈취 블록의 사용가능 기간을 지나 효력을 잃었습니다. B. 어떤 사람들은 냄새에 특별히 민감합니다.	A. 탈취 블록을 교체합니다. B.없음.

기타

증상	가능한 원인	처리 방법
15.제품이 느슨해 졌습니다.	A.고정 플레이트의 나사가 느슨해졌습니다.	A.고정 플레이트의 나사를 조입니다.

Service Parts

K-4107KR

1185019-SP
Installation Screw
Attachment



1102014-SP
Clip Attachment



1184968-SP
Cover Bumper



1183663-SP
Nozzle Gen Assy.



1085189-SP
Inlet Attachment

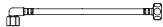

1194769-SP
CUSHION assy.

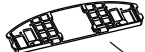

1185018-SP
Mounting Plate
Assy



1185006-SP
Water Tank Assy.



1184969-SP
Inlet Filter



1186587-SP
Cable of LED
night lamp

1185014-SP-
LID, COVER assy.



1184962-SP-
DE Back

1185012-SP
Deodorizer Assy.



1150820-SP
FILTER BLOCK



1185016-SP
Lid Damp Assy.



1185010-SP
air pump assy.

1085096-SP-
Fan Door

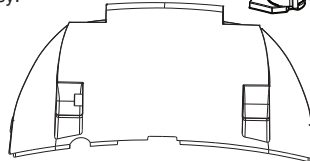

1185015-SP
Seat Damp Assy.



1205946-SP
Control Module Assy.

1186590-SP
Dry Centrifugal
Fan



1085187-SP
T-Valve



1185004-SP
Heater Assy.



1205727-SP
Power Line With
Gfci Plug



1185003-SP
Flowmeter Assy.



1194770-SP
Assign-nozzle Assy.



1186150-SP
Power Module
Assy.



1207946-SP
Membrane Side
keyboard



1186595-SP
PCBA Side
Keyboard



1182246-SP
Drive Module
Assy.(220V)



1185002-SP
Decompression-
Electromagnetic valve Assy.

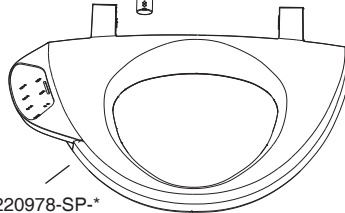

1220978-SP-
RING asm.



1185011-SP
Air Dryer Assy.

*Finish/color code must be specified when ordering.

THREE-YEAR LIMITED WARRANTY

Kohler warrants this plumbing product to be free of defects in material and workmanship during normal residential use for three years from date of purchase. **This warranty only applies to the plumbing product purchased and installed in countries/regions as listed below.**

If a defect is found in normal residential use, Kohler will, at its election, repair, replace or make appropriate adjustment where Kohler inspection discloses any such defects occurring in normal usage within three (3) years after date of purchase. Kohler is not responsible for labor charges, removal or installation, or other incidental or consequential costs other than those noted above.

If the product is used commercially, Kohler warrants that the product will be free from defects in materials and workmanship for one (1) year from the date of purchase, with all other terms of this warranty applying except duration.

IMPLIED WARRANTIES INCLUDING THAT OF MERCHANTABILITY AND FITNESS FOR A PARTICULAR PURPOSE ARE EXPRESSLY LIMITED IN DURATION TO THE DURATION OF THIS WARRANTY. KOHLER AND/OR SELLER DISCLAIMS ANY LIABILITY FOR SPECIAL, INCIDENTAL OR CONSEQUENTIAL DAMAGES.

Some countries/regions do not allow limitations on how long an implied warranty lasts, or the exclusion or limitation of special, incidental or consequential damages, so these limitations and exclusions may not apply to you. This warranty gives you specific legal rights. You may also have other rights which vary from country/region to country/region. This warranty is to the original consumer purchaser only, and excludes product damage due to accident, installation error, product abuse, or product misuse, whether performed by a contractor, service company, or the consumer. Improper care and cleaning will void the warranty.

To obtain warranty service, please contact your Dealer or Plumbing Contractor, or a Kohler Service Center using the information provided below. **Please be sure to provide all pertinent information regarding your claim, including a complete description of the problem, the product, model number, color, finish, the date the product was purchased and from whom the product was purchased. Proof of purchase (original sales invoice) must be provided to Kohler with all warranty claims.**

Kohler Warranty Obligor/Service Center for Region or Country of Purchase

Region/Country of Purchase

Address

China mainland

Kohler China Investment Co., Ltd.
Central Customer Service Centre
No.158, Jiang Chang San Road, Zhabei District,
Shanghai 200436, PRC
Toll-Free Service Call: 800-820-2628
400-820-2628

Thailand

Kohler (Thailand) Public Company Limited
16 FL. Jasmine City Bldg., 2 Sukhumvit 23,
Wattana, Bangkok, Thailand. 10110
Tel: +(66) 2204 6222
Fax: +(66) 2204 6224
E-mail: callcenterthailand@kohler.com

Hong Kong, Macau
and Taiwan

Kohler Asia Pacific Limited
29/F, Siu On Center, 188 Lockhart Road,
Wanchai, Hong Kong
Tel: +(852) 3125 7728
Fax: +(852) 2802 2162

Singapore, the
Philippines, Malaysia,
Indonesia, Vietnam,
South Korea, Brunei
and Japan,

Asia Customer Service Centre
No.158, Jiang Chang San Road, Zhabei District,
Shanghai, PRC Post Code: 200436
Tel: +(86) 21 2606 2572
Fax: +(86) 21 6107 8900

This is Kohler's exclusive written warranty.

重要的安全警示

保存這些說明



警告：觸電，火災或人身傷害的危險。本產品必須安全接地。只能連接到專用的220~240V AC，50/60Hz，10A，帶接地故障斷路器或接地漏電保護器的電路中。



警告：觸電或產品損傷的危險。不要把產品浸在水中。

重要！產品損傷的危險。不要安裝在水可能濺到的地方。

重要！產品損傷的危險。不要把產品安裝在過分潮濕的地方，在這種地方，水氣可能凝聚在產品表面。請始終保持使用環境有足夠的通風，以防止電子組件的損壞。

重要！產品損壞或財產損失的危險。硬推、硬拉水管接頭可能造成水滲漏。

重要！產品損壞的危險。不要在噴嘴上施加過大的力，否則產品可能損壞。

重要！產品損壞的危險。在一些水可能在水管中結冰的地方，要做好水管保溫的安排。任何留在產品裡的水在冬天儲存時都可能結冰。在重新安裝或使用前請保證產品暖至室溫。

重要！產品損壞的危險。在安裝工作完成之前不要接通電源，這可能導致產品故障。

注意：溫暖的氣候時，熱保護器在存儲或運輸過程中可能失靈，導致產品不工作。在重新安裝或使用前請保證產品冷至室溫。

當使用電器產品時，尤其當兒童在場時，應該遵守基本的安全防範，包括如下：

危險 - 降低觸電的危險：

- 不要把此設備放置在可能掉落或可能被拉入浴缸及水槽的地方。
- 不要放置或掉到水及其他液體中。
- 不要觸及掉進水中的產品。如果掉進水中，請立刻拔掉插頭。

重要的安全警示（續）

警告 - 避免低溫灼傷、觸電、火災或人身損傷

- 當兒童、老年人、殘疾人使用或靠近此產品時，近距離的監護是必需的。兒童不應該被允許使用或接觸此產品。不要讓兒童獨自呆在安裝有此產品的房間。
- 對於無法自己進行溫度調節操作的兒童和老人，需要幫助將座便蓋的圈溫、沖水溫度及風溫調節到合適的檔位。
- 僅按照手冊中所描述的方式使用本產品，請勿使用科勒不推薦的附件。
- 使用時請勿倚靠在蓋板上，以免損壞產品。
- 如果有以下情況請不要使用本產品：電源線、插頭及產品有損壞；產品不能正常工作；產品掉入水中。
- 根據安裝說明正確地安裝本產品。
- 只有專業人士可以修理此產品。不要試圖自己維修此產品，否則保養無效。
- 使電源線遠離加熱表面。
- 不要把任何物品掉入或插入管路和開孔處。
- 不要在戶外或者微粒噴霧設備正在被使用的地方使用本產品。也不要給在給養的地方使用本產品。
- 在通電之前必須按照說明書中的要求接地。
- 防止將水淋到電源插頭上。
- 請避免長時間讓裸露的皮膚接觸加熱座圈，以免低溫灼傷。
- 如果電源線損壞，為了避免危險，必須由製造商、其維修部或類似部門的專業人員更換。

規格				
供水水壓(動壓)		0.7kgf/cm ² (動壓)~7.5 kgf/cm ² (0.07MPa.(動壓)~ 0.74MPa.)		
規格		220~240V AC 50/60Hz 1200W		
電源線長度		約1.5m		
產品外型尺寸		521mm x 435mm x 157mm		
產品重量		約3.0Kg		
使用環境		1~40℃		
清洗	出水量	臀部沖洗	0.40~0.79L/min	
		女性沖洗	0.40~0.79L/min	
	瞬時加熱功率		1200W	
	清洗水溫調節		五檔可調(室溫~39℃)	
	沖洗時間(最長)		300s	
	噴嘴數量		1	
	噴嘴位置調節		5檔	
	脈衝按摩		開/關	
	移動沖洗		開/關	
	安全裝置	水溫過熱保護	溫度保險絲、過熱斷路器	
逆流防止		單向閥		
舒適	座圈保溫	最大加熱功率	40W	
		溫度調節	五檔可調(室溫~39℃)	
		安全裝置	溫度保險絲、過熱斷路器	
	上蓋		緩降	
	座圈		緩降	
	暖風	風機最大風量	0.19m ³ /min	
		最大加熱功率	200W	
		溫度調節	五檔可調	
		安全裝置	溫度保險絲、過熱斷路器	
	除臭功能	風機最大風量	0.19m ³ /min	
衛生	噴嘴自清洗		有	
	快速拆除本體		推動釋放鍵	
	抗菌材料		座圈、蓋板	
	噴嘴UV殺菌		每天一次	
其它功能	控制面板		位於座圈側面	
	落座感應		位於座圈內部	
	夜燈		2個藍色LED燈	

謝謝您選擇科勒公司

謝謝您選擇科勒。科勒技術提供了可靠性能和優雅生活的結合，滿足了您未來幾年的需求。科勒產品的美觀和可靠性將滿足您最挑剔的眼光。我們為我們科勒的產品感到非常地自豪，相信您也會。

請花幾分鐘閱讀一下這本用戶手冊，特別注意維護和清洗說明。

這本說明書中所有的信息基於最新公開的產品信息。在科勒，我們一貫堅持改善我們產品的質量。我們保留在任何時候不通知的情況下改變產品特性，包裝或實用性的權利。

控制面板

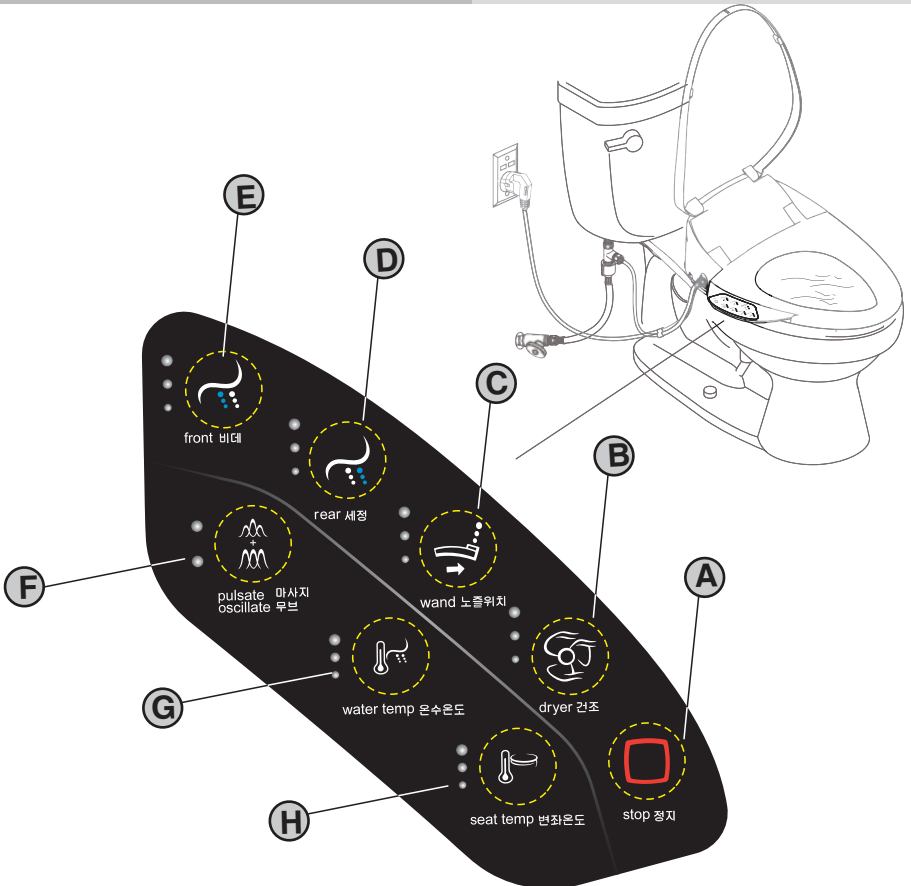

使用方法

□ A - 停止

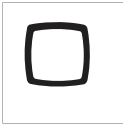

在沖洗或暖風開啟時，按此鍵可停止沖洗或暖風功能。用戶落座後，除臭功能自動開啟。僅有除臭功能開啟時，按停止鍵則關閉除臭功能。除臭功能關閉後，在重新落座前，將不再重新開啟。



長按停止按鍵2秒，可關閉或打開夜燈，關閉時（長音），夜燈不亮；打開時（短音），夜燈受光線控制（外部光線暗則亮，反之則滅）。

□ B - 暖風



落座時，按暖風鍵啟動暖風功能，如此時正在使用沖洗功能，將被立即停止。

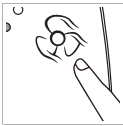

指示燈會顯示當前的暖風溫度，繼續按暖風鍵，暖風溫度按低檔、中低檔、中檔、中高檔、高檔、中高檔循環變化。連續工作約4分鐘，該功能自動停止。

□ C - 噴管移動



在沖洗狀態下，按噴管移動鍵後，啟動噴管移動功能；繼續按噴管移動鍵可改變噴管位置，位置按短距離、中短距離、中距離、中長距離、長距離、中長距離循環變化。

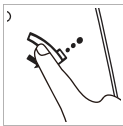

在無人落座情況下，長按噴管移動鍵2秒以上，噴管伸出。再次按噴管移動鍵，噴管縮回。如果2分鐘內無任何按鍵動作，噴管自動縮回。

□ D - 臀部沖洗



落座時，按臀部沖洗鍵，啟動臀部沖洗，並顯示現在的沖洗強度。如此時正在使用暖風功能，將被立即停止。



在開啟臀部沖洗功能的狀態下，繼續按臀部沖洗鍵可改變沖洗強度，強度按小檔、小中檔、中檔、中大檔、大檔、中大檔循環變化。連續沖洗約5分鐘後，自動停止。

□ E - 女性沖洗



落座時，按女性沖洗鍵，啟動女性沖洗（女性專用），並顯示現在的沖洗強度。如此時正在使用暖風功能，將被立即停止。在開啟女性沖洗功能的狀態下，繼續按女性沖洗鍵可改變沖洗強度，強度按小檔、小中檔、中檔、中大檔、大檔、中大檔循環變化。連續沖洗5分鐘，自動停止。

□ F - 脈衝按摩+移動沖洗

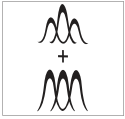

在沖洗狀態下，按脈衝按摩/移動沖洗鍵後，啟動脈衝按摩沖洗。

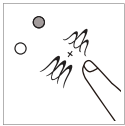

每次按鍵，按脈衝按摩、移動沖洗、脈衝按摩+移動沖洗、關閉脈衝按摩+移動沖洗（返回女性沖洗或臀部沖洗）循環，並點亮相應的小燈。如果關閉脈衝按摩/移動沖洗（返回女性沖洗或臀部沖洗），指示燈不亮。

□ G - 水溫



按水溫鍵可設置沖洗水的溫度，每次按鍵，按關、低檔、中低檔、中檔、中高檔、高檔、中高檔循環，設置衝洗水溫，並切換點亮水溫參數指示燈。如果是處於關閉狀態，指示燈不亮。

□ H - 圈溫



按座圈溫度鍵可設置座圈溫度，每次按鍵，按關、低檔、中低檔、中檔、中高檔、高檔、中高檔循環，設置座圈溫度，並切換點亮圈溫參數指示燈。如果是處於關閉狀態，指示燈不亮。

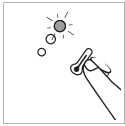

長按圈溫按鍵2秒，可打開（短音）/關閉（長音）節能功能，圈溫燈閃爍表示節能功能打開，圈溫燈停止閃爍表示節能功能關閉。落座，則取消節能模式。

開機後第一周，座圈自動檢測用戶使用習慣；從第二週開始，座圈根據上週檢測到的用戶使用頻率，在頻率低的期間內，自動進入節能狀態；第三週再根據第二週檢測到數據，自動判定節能狀態，如此循環。

□ I - 檔位說明

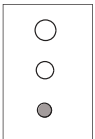

低檔
小燈亮

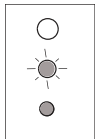

中低檔
小燈亮，中
燈閃爍

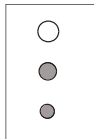

中檔
小燈和中
燈同時亮

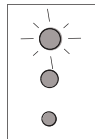

中高檔
小燈和中燈亮，
大燈閃爍

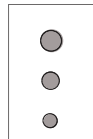

高檔
小燈、中燈和
大燈同時亮

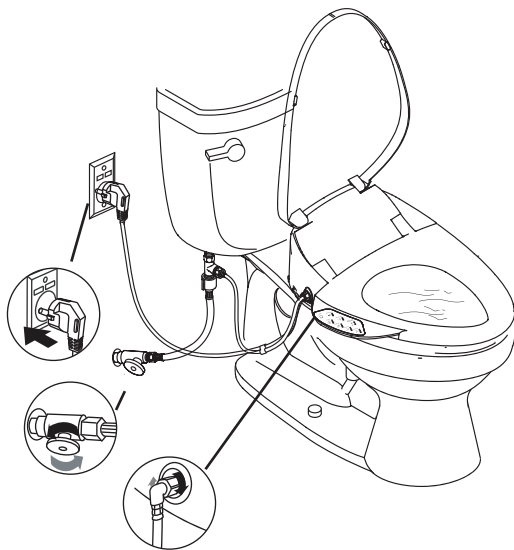

初次使用前準備

- 接上進水軟管，打開止水閥，插上電源。
- 把電源線插上電源插座，座便蓋發出短蜂鳴1次，噴管伸縮1次，側鍵盤上背光燈點亮，夜燈閃爍，直至初始化結束。
- 初始化過程中，可聽到電機轉動聲和流水聲，均屬正常。
- 初次使用時為出廠設置狀態：

女性沖洗：	圈溫：中檔
• 水溫：中檔	風溫：中檔
• 水流強度：中檔	夜燈：開
• 沖洗位置：中檔	節能模式：關閉
- 臀部沖洗：

• 水溫：中檔
• 水流強度：中檔
• 沖洗位置：中檔



功能測試

- 用塑料布包裹著座圈上，防止測試時水從座便器中噴出。
- 座圈設計為落座感應模式。為了激活座圈達到測試的目的，首先面對座便器，然後把手或者一塊濕布放在座圈右邊離前端大約三分之一處（感應區域）。
- 繼續參照“控制面板”和“使用方法”部分來測試座便蓋的不同功能。

維護和清洗

重要注意事項：

⚠ 重要 不要用水直接沖洗座便蓋。

- **測試** - 首先用清洗液在座便蓋不顯眼的地方測試，如果確認清洗液不會對座便蓋外表造成損壞然後再應用於整個表面。

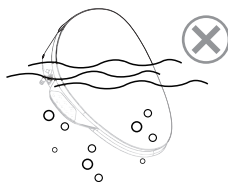

- **不要讓清潔劑浸泡** - 禁止將該產品浸泡在清潔劑中。

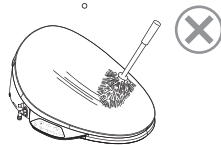

- **避免表面粗糙的材料** - 使用柔軟、潮濕的海綿或棉質布，不要用表面粗糙的材料來清洗表面，例如刷子、沖刷墊等。



- **擦洗** - 加上清潔劑後，立即用濕布擦洗表面，擦除噴到表面的清潔劑和髒物。

清洗座圈

- 避免使用含有研磨成分的清潔劑和消毒劑。



維護提示：用洗滌劑和水的混合液體或任何列為可用於座圈清潔的產品清洗座圈，用柔軟濕潤的海綿或者布。用軟毛巾擦乾，在空氣中讓座圈自然乾燥。

- 不允許帶腐蝕的化學品或化妝品（例如指甲油或須後水）和座圈接觸，避免破壞表面。



⚠ 注意 不遵守這些清洗說明可能使科勒的保養無效。

⚠ 注意 清洗程序的成功取決於例如水的硬度和溫度，使用成分的精確數量，清洗規則的改變和被清洗產品的狀態等因素。因為這些因素會有變化，科勒不能保證所提到的規則的有效性。

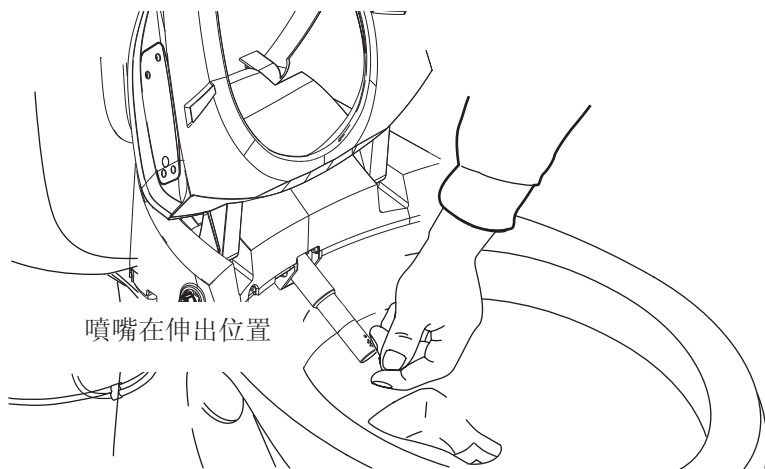

清洗噴嘴

注意：當座便蓋不被使用或啟動的時候，噴嘴才能伸出以便清洗。

- 翻開上蓋和座圈。
- 長按噴管移動鍵**2**秒以上，待噴管完全伸出後，用軟鬃毛刷清洗噴嘴。
- 噴嘴清洗完畢後，長按噴管移動鍵**2**秒以上，噴管縮回。或等待噴管自動縮回。

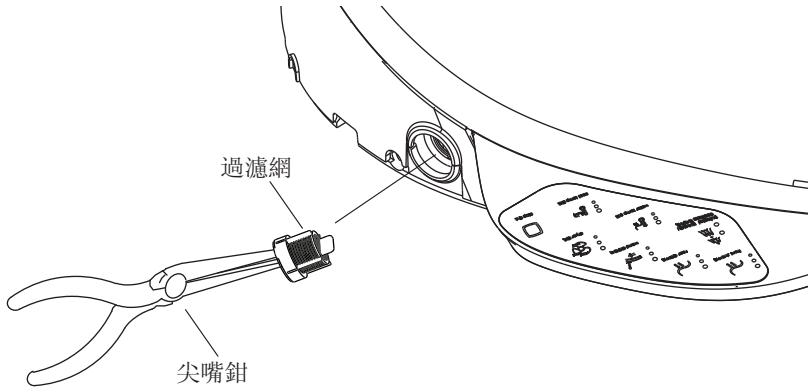

清洗過濾網

重要！產品損壞的危險。小心不要造成接頭損壞。

- 關閉供水閥。
- 卸下座便蓋供水管。
- 用尖嘴鉗小心的將過濾網從產品的進水口移出（見圖示）。
- 用軟鬃毛刷清洗過濾網。
- 重新裝好過濾網。
- 小心對正螺紋，重新裝好座便蓋的供水管。
- 為防洩漏，請檢查所有的連接，並做必要調整。
- 開啟供水閥門。

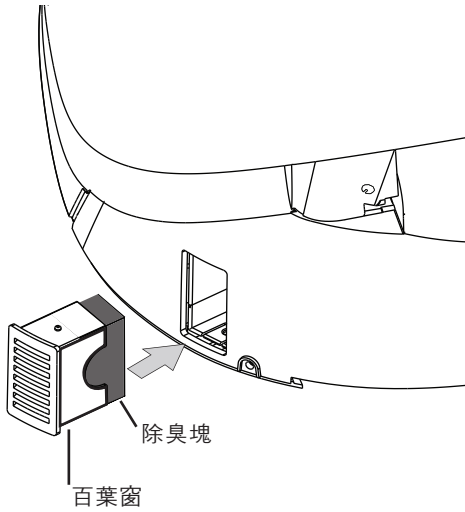

更換除臭塊

重要！產品損壞的危險。拆卸百葉窗時不能用力太大，否則可能損壞百葉窗。

- 從產品側面將百葉窗取下。
- 用手指夾住除臭塊，向外拉出。
- 重新裝入新的除臭塊。
- 重新裝上百葉窗。
- 安裝新除臭塊前先檢查是否有異物留存在管內，如有需要提起產品前端使異物掉出風管。

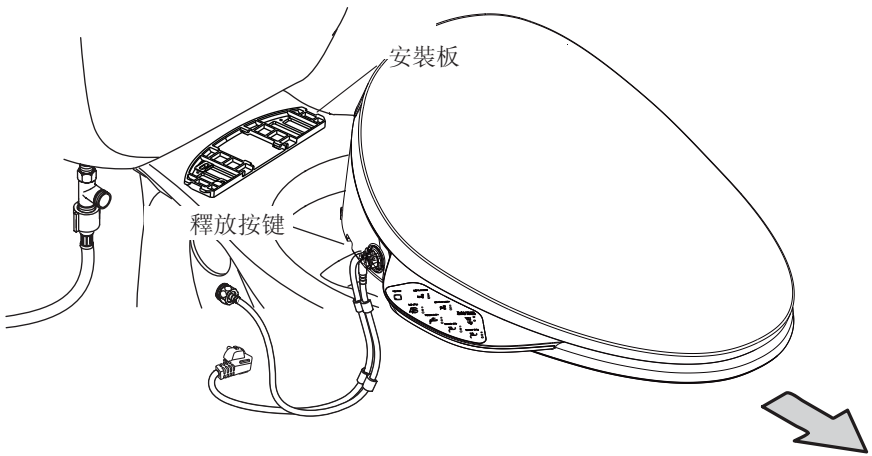

移除座便蓋

- 關閉供水閥。
- 開啟座便器沖洗功能減輕供水管壓力。
- 拔掉座便蓋電源插頭。
- 斷開供水管和三通的連接。
- 按釋放按鍵（見圖示）。
- 向前移動座便蓋，使座便蓋和安裝板分離。

注意：座便蓋可能會有水，是否被排放完全，詳情參見“座便蓋排水”。

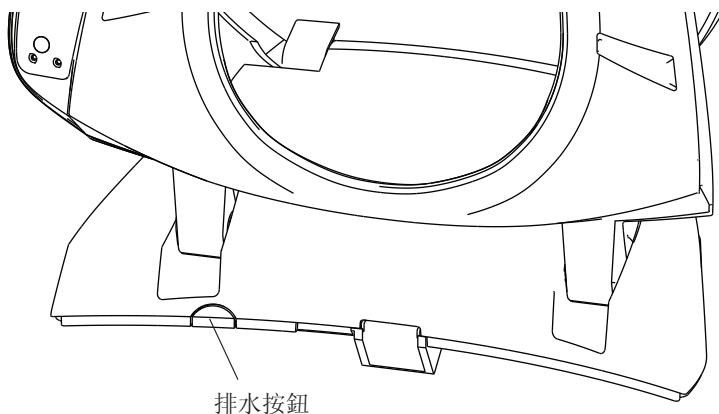

座便蓋排水



警告：產品損壞的危險。當座便蓋長期不使用，或環境溫度有可能降低到冰點以下時，應事先排盡座便蓋管路中的殘留水。

- 切斷供水，拔下插頭。
- 從座便器上拆下座便蓋，參考“移除座便蓋”部分。
- 按壓排水按鈕。
- 從座便蓋中把水排除。

疑難解答

這份疑難解答只提供普通幫助。科勒授權的服務代表能解決相關的電器問題。保養維修服務方面的問題，請聯繫你的經銷商或批發商。

疑難解答 (續)

一般功能

故障現象	可能原因	建議措施
1. 不能操作。	<p>A. 停電。</p> <p>B. 未接上電源線。</p> <p>C. 電源線漏電插頭保護開關未復位。</p> <p>D. 人體未接觸座圈感應區域。</p> <p>E. 熱保護器開啟自動保護。</p> <p>F. 以上措施都不見效。</p>	<p>A. 等到電力恢復。</p> <p>B. 將插頭插在插座上。</p> <p>C. 按下插頭上的複位按鈕。</p> <p>D. 接觸座圈感應區域。</p> <p>E. 將產品在室溫環境下靜置一段時間。</p> <p>F. 聯繫科勒服務代表。</p>
2. 座圈鬆動。	A. 螺絲和螺母未擰緊。	A. 依據安裝指導擰緊螺絲和螺母。
3. 噴管不能出水。	<p>A. 座圈未能感應到使用者。</p> <p>B. 供水閥關閉。</p> <p>C. 過濾網阻塞。</p> <p>D. 以上措施都不見效。</p>	<p>A. 調整坐姿。皮膚與座圈之間不能有物體隔離，如褲子等。</p> <p>B. 關閉電源，排除供水故障，重新通電。</p> <p>C. 查看“清洗過濾網”部分。</p> <p>D. 聯繫科勒服務代表。</p>

清潔功能

故障現象	可能原因	建議措施
4. 無水流。	<p>A. 供水閥已關。</p> <p>B. 落座感應器沒有探測到使用者。</p>	<p>A. 打開供水閥。</p> <p>B. 在“功能測試”部分查看激活座圈信息。</p>
5. 沖洗水壓小。	<p>A. 過濾網阻塞。</p> <p>B. 供水水壓不足。</p>	<p>A. 查看“清洗過濾網”部分。</p> <p>B. 提高水壓到產品要求的水壓範圍。</p>
6. 完成清洗前水就停止從噴嘴中噴出。	<p>A. 連續沖洗5分鐘，沖洗功能自動停止。</p> <p>B. 落座感應器沒有探測到使用者。</p>	<p>A. 如需要，請再次按下沖洗按鈕。</p> <p>B. 在“功能測試”部分查看激活座圈信息。</p>
7. 沖洗時有水從噴嘴旁邊的孔中流出。	A. 產品內部防止水壓過高的保護。	A. 正常現象。

疑難解答 (續)		
8. 落座時，有水從噴嘴處流出。	A. 長時間無人使用時，將在使用前自動排放噴管內部的殘留水。	A. 正常現象。
座圈緩降		
故障現象	可能原因	建議措施
9. 座圈和蓋板的關閉速度在夏季和冬季有所不同。	A. 因室內溫度變化。	A. 正常現象。
落座感應器		
故障現象	可能原因	建議措施
10. 不使用时按下清洗按鍵，清洗功能啟用。	A. 落座感應器被物體覆蓋或座位是濕的。	A. 擦拭落座感應器區域的水或異物。
11. 即使坐著，清洗功能也不起作用。	A. 當前的坐姿，落座感應器不能檢測到使用者。	A. 變換坐的姿勢。
暖風功能		
故障現象	可能原因	建議措施
12. 使用過程中暖風風機停止工作。	A. 連續使用烘乾功能4分中，風機自動停止。	A. 再次按暖風按鍵。
除臭功能		
故障現象	可能原因	建議措施
13. 除臭風機不工作。	A. 落座感應器沒有探測到使用者。 B. 誤按下停止鍵。	A. 在“功能測試”部分查看激活座圈信息。 B. 在“使用方法”部分查看激活座圈信息。
14. 氣味未消除。	A. 除臭塊因使用過久而失效。 B. 某些人對氣味特別敏感。	A. 更換除臭塊。 B. 無
其他		
故障現象	可能原因	建議措施
15. 產品鬆動。	A. 固定產品的安裝板的螺絲鬆動。	A. 擰緊安裝板螺絲。

維修配件圖
K-4107KR

1185019-SP
安裝螺絲附件包



1102014-SP
線夾附件包



1184968-SP
緩衝墊



1183663-SP
基本型噴嘴組件



1085189-SP
進水附件包



1185010-SP
氣泵組件



1186590-SP
乾燥風機



1085187-SP
三通



1205727-SP
電源線



1186595-SP
側鍵盤電路板

1207946-SP
鍵盤面板貼膜(按鍵)



1185002-SP
進水閥組件

1194769-SP
座圈緩衝墊組件

1185018-SP
安裝板組件

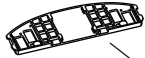

1185006-SP
緩沖水箱組件



1085096-SP*
風門



1185004-SP
加熱組件



1185003-SP
流量計組件



1220978-SP*
座圈組件

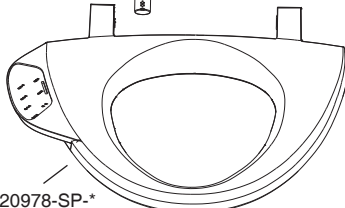

1184969-SP
進水閥濾網



1185015-SP
座圈阻尼組件



1185014-SP*
上蓋組件

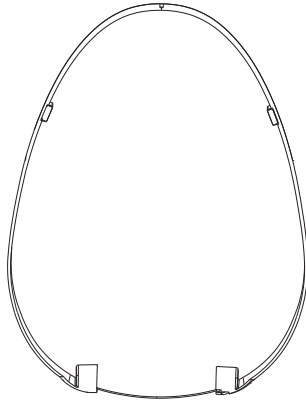

1186587-SP
LED夜燈線束



1184962-SP*
除臭百葉窗



1185012-SP
除臭組件

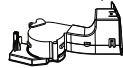

1150820-SP
脫臭塊(觸媒型)



1185016-SP
上蓋阻尼組件



1205946-SP
主控模塊組件



1186150-SP
電源模塊組件



1182246-SP
驅動模塊組件(220V)



1185011-SP
暖風組件

*訂購時請說明顏色編號。

三年有限擔保

科勒擔保本廚衛產品在正常家用的情況下自購買之日起三年內無材料及製造工藝上的瑕疵。本擔保僅適用於在下列國家/地區購買並安裝的廚衛產品。

在擔保期內，如發現產品在正常家用的情況下存在瑕疵，經核查後，科勒將自行決定對產品進行修理、更換、或是作適當的調整。科勒不承擔上述成本以外的人工成本、拆除或安裝的成本，或其他附帶的或衍生性的支出。

如產品被用於商業目的，則科勒擔保該產品自購買之日起一年內無材料及製造工藝上的瑕疵。除擔保期限以外，本擔保的其他條款均適用。

產品的默示擔保（包括對產品的適銷性和適用於特定目的的擔保）僅限於擔保期內有效，並且科勒對任何特殊、附帶或衍生性損害賠償不承擔責任。

有些國家/地區不允許限定擔保期或對特殊、附帶或衍生性損害賠償進行排除或限制，所以上述限制和排除可能對您不適用。本擔保賦予您明確的法律權利。您可能還享有其他權利，該等權利因國家/地區的不同而有所區別。本擔保僅適用於原購客戶。由於意外、安裝錯誤、誤用或使用不當造成的產品損害不屬於擔保範圍之內。不適當的保養和清潔將導致擔保無效。

為獲得擔保服務，請聯繫您的經銷商或承包商，或聯繫下列科勒服務中心。請確保提供所有相關的信息，包括完整的問題描述、型號、顏色、表面鍍層、購買時間及銷售方。請務必同時提供購買憑證（原銷售發票）。

各產品購買地區/國家科勒擔保服務中心

產品購買地區/國家

地址

中國大陸

科勒（中國）投資有限公司
中央客戶服務中心
中國上海市閘北區江場三路158號
郵編：200436
免費諮詢保修電話： +（86）800-820-2628
400-820-2628

泰國

Kohler (Thailand) Public Company Limited
16 FL. Jasmine City Bldg., 2 Sukhumvit 23,
Wattana, Bangkok, Thailand. 10110
電話: +(66) 2204 6222
傳真: +(66) 2204 6224
E-mail: callcenterthailand@kohler.com

香港, 澳門和台灣

科勒亞洲有限公司
香港灣仔駱克道188號兆安中心29/F
電話: +(852) 3125 7728
傳真: +(852) 2802 2162

新加坡、菲律賓、
馬來西亞、印度尼西亞、
越南, 韓國,
文萊和日本

亞洲客戶服務中心
中國上海市閘北區江場三路158號
郵編：200436
電話: +(86) 21 2606 2572
傳真: +(86) 21 6107 8900...

這是我們全部的書面擔保!